



 **STREAMLINE™**

# Specialist Cleaning Solutions

CATALOGUE V1





# Contents

<b>INTERNAL WINDOW CLEANING</b>	<b>6 - 15</b>
Ecoshine™ Kit	8 - 9
Ecoshine™ Pro Kit	10 - 11
Dragonfly® 4 Kit	12 - 13
<b>Pole Selection</b>	<b>14 - 15</b>
<b>EXTERNAL WINDOW CLEANING</b>	<b>16 - 29</b>
<b>Soft Water Areas</b>	
Streamflo® 25	18 - 19
Streamflo® 120	20 - 21
<b>Hard Water Areas</b>	
Mobi® Midget	22 - 23
Mobi® Median	24 - 25
Mobi® Maxi	26 - 27
<b>Pole Selection</b>	<b>28 - 29</b>

<b>ROOF &amp; RENDER CLEANING</b>	<b>30 - 45</b>
<b>Roof Scraping</b>	
OVA8® Roof Scraper	32 - 33
<b>Softwashing</b>	
Softclean™ Mini	34 - 35
Softclean™ Dose	36 - 37
<b>High Pressure</b>	
Highline™ 150	38 - 39
<b>Facia Cleaning</b>	
Streamflo® 25	40 - 41
<b>Pole Selection</b>	<b>42 - 45</b>

<b>GUTTER VAC KITS</b>	<b>46 - 53</b>
<b>Gutter Vacuum Kits</b>	
Streamvac™ 30Ltr	48 - 49
Streamvac™ 70Ltr	50 - 51
<b>Pole Kits</b>	
<b>Pole Selection</b>	<b>52 - 53</b>
<b>TRANSPORT CLEANING</b>	<b>54 - 79</b>
<b>Yacht &amp; Cargo Ship Cleaning</b>	
Mobi® Carry	56 - 57
Mobi® Median	58 - 59
Highline™ 150	60 - 61

<b>Bus &amp; Truck Cleaning Low Pressure</b>	
Streamflo® 25	62 - 63
Streamflo® 120	64 - 65
<b>Bus &amp; Truck Cleaning High Pressure</b>	
Highline™ 150	66 - 67
Highline™ 276	68 - 69
<b>Train Cleaning</b>	
Streamflo® 120	70 - 71
<b>Bus Stop Cleaning</b>	
Streamflo® 25	72 - 73
Streamflo® 120	74 - 75
<b>Pole Selection</b>	<b>76 - 79</b>

<b>EXTERNAL CLEANING</b>	<b>80 - 91</b>
<b>Patios &amp; Driveways</b>	
Highline™ 150	82 - 83
Highline™ 276	84 - 85
<b>Bike Rack Cleaning</b>	
Streamflo® 25	86 - 87
Streamflo® 120	88 - 89
<b>Van System</b>	
Hotcube Van System	90 - 91

<b>SPECIALIST CLEANING</b>	<b>92 - 97</b>
<b>CCTV Cleaning</b>	
Dragonfly® CCTV	94 - 95
<b>Internal Dusting</b>	
Streamvac™ Dusting Kit	96 - 97
<b>OUR TEAM &amp; CORE VALUES</b>	<b>98</b>
<b>CONTACT &amp; TERMINOLOGY</b>	<b>99</b>





Streamline™ is a family-owned business founded in 2005 by brothers Richard and Mike with a commitment to customer satisfaction and being the best specialist cleaning equipment manufacturer. Originating in Plymouth, UK, the company quickly emerged as a leading van fit-out specialist, focusing on high-reach window cleaning solutions.





## International Presence

With warehouses in France and Germany, services have been expanded globally, catering to the needs of clients across different regions.

## Specialisation In Van Fitouts

As van fit-out specialists, Streamline® provide comprehensive solutions for both domestic window cleaners and professional contract cleaners and facilities managers.



 @streamlinecleaningsolutions  
 @streamlinecleaningsolutions

## On The Road Technicians

Whether it's a routine maintenance check, a troubleshooting task, or an urgent repair, our technicians are equipped with the expertise and resources to swiftly address any issues, minimising downtime and maximising productivity for your business.



## Commitment To Our Customers

### ISO9001:2015 Accreditation:

Streamline® has been awarded ISO9001:2015 accreditation, reflecting commitment to efficiency, professionalism, and continuous improvement.

### Environmental Policy

They maintain an environmental policy, underlining their dedication to sustainable practices.

### Professionalism and Efficiency

A commitment to an efficient and professional approach includes a comprehensive range, competitive prices, immediate availability, and a service second to none.



## Innovation At The Core

An in-house design team, equipped with 3D printing and CNC capabilities, focuses on innovation. Continually expanding the range to offer cutting-edge products for a safer, easier and more cost-effective cleaning experience.

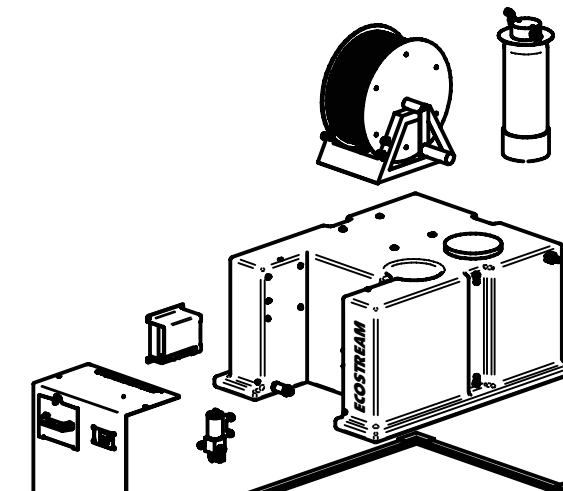

www.streamline.systems

| sales@streamline.systems

| +44 (0) 1626 830 830





# Internal Cleaning Kits

## Internal Windows Stairwells Atriums

Our professional-grade internal window cleaning kits offer a comprehensive solution for maintaining crystal-clear windows in various commercial settings. Designed for versatility, these kits prove indispensable in areas such as car showrooms, stairwells, and atriums within office blocks, schools, colleges, hotels, airports, and shopping centres.

The adaptability of these kits extends to both high and low windows, ensuring that windows of varying heights, including roof lights and stairs, can be effectively and efficiently cleaned. Tailored to the specific needs of professionals, our internal kits not only enhance visibility but also contribute to creating a pristine and inviting environment for businesses and institutions alike.



**ECOSHINE™** See Page 8 - 9

**01** **ECOSHINE™**



The Ecoshine™ kit is ideal for gentle cleaning tasks, featuring a telescopic tool designed for indoor windows and other various washable surfaces.

See Page 8 - 9

**02** **ECOSHINE™ PRO**



The Ecoshine™ Pro, a telescopic cleaning tool designed for indoor windows and other washable surfaces, stands out for its sturdy construction, manoeuvrability, and user-friendly operation.

See Page 10 - 11

**03** **DRAGONFLY™ 4**



This innovative backpack window cleaning tool enables you to clean elevated windows while keeping your feet firmly on the ground.

See Page 12 - 13



# ECOSHINE™

The Ecoshine™ kit is ideal for gentle cleaning tasks, featuring a telescopic tool designed for indoor windows and other various washable surfaces. It boasts durability, manoeuvrability, and user-friendly operation, harnessing the cleaning capabilities of pure water and microfiber. This combination effectively eliminates dirt from windows and other non-porous surfaces swiftly and with minimal effort.

## IDEAL FOR

- Partition walls
- Mirrors & showers
- Ground windows
- Shop windows
- Display cabinets
- Public transport windows
- Digital signs

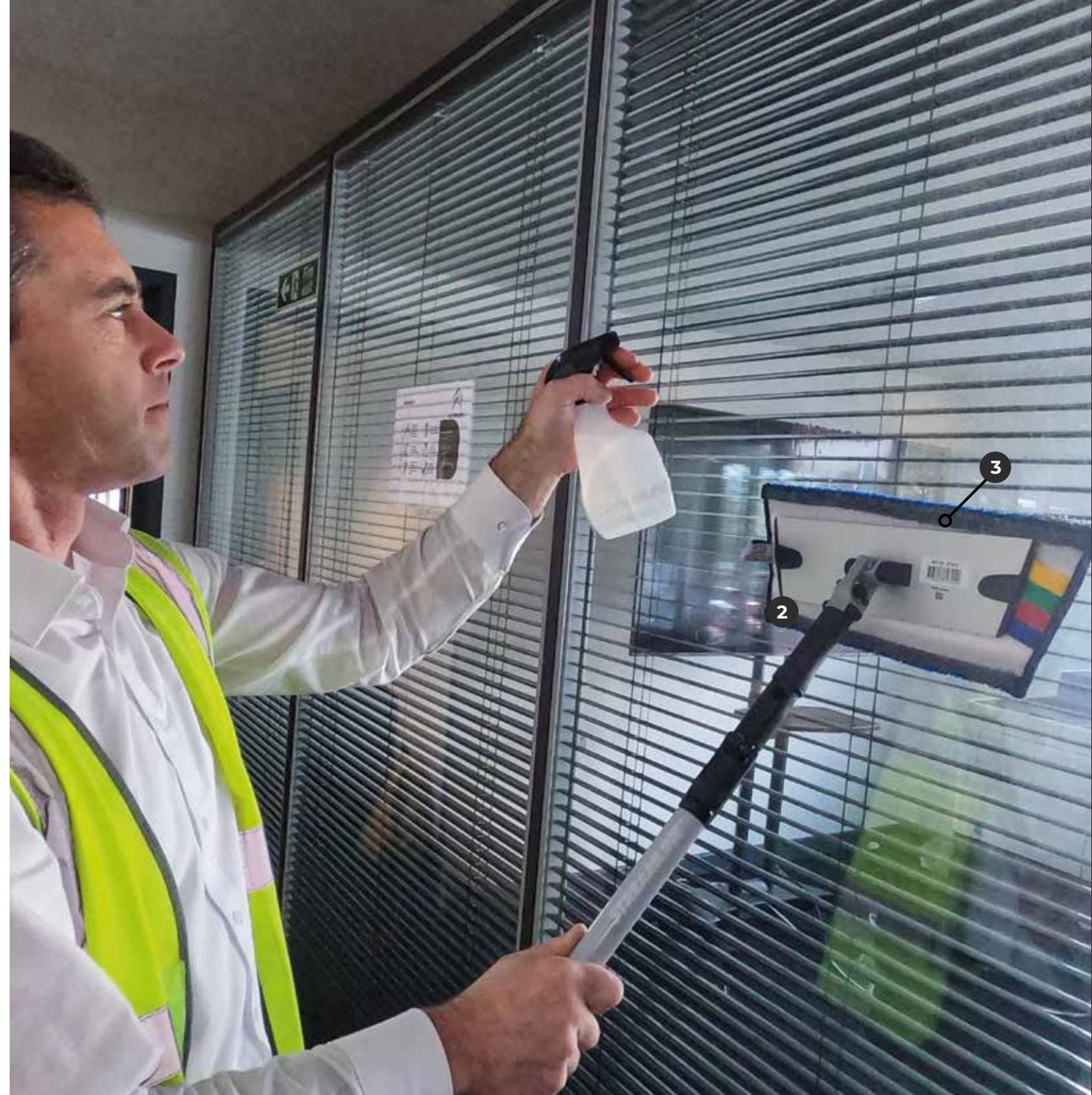

## 1 System

ECOSHINE™

THIS KIT INCLUDES

## 2 Mop Plate

1x  
25cm Aluminium Mop Plate  
360° Rotating mop plate  
with locking feature.



## 3 Microfibre Pads

2x  
Microfibre Scrub Mops  
Suitable for cleaning soiled  
glass and removing  
light dust.



2x  
30cm Microfibre Scrub Cloths  
Suitable for cleaning soiled  
glass and removing  
light dust.



## 4 Accessories

1x  
300ml Spray Bottle

1x  
Holdall Bag



Strong velcro grip on both  
pad and mop plate for a  
secure hold



Secure Quick Release  
For Mop Plate  
Replacements

Horizontal Rotation  
Lock For Precise  
Cleaning

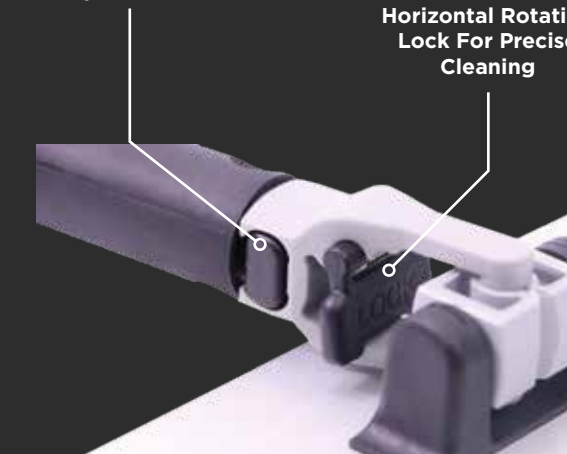

Tank Size	300ml
Minimum Pole Length	740mm
Pole Length	1.3mtr
Achievable Height	9ft
Pole Weight	0.42kg
Pole Material	Glass Fibre



# ECOSHINE™ PRO

The Ecoshine™ Pro, a telescopic cleaning tool designed for indoor windows and other washable surfaces, stands out for its sturdy construction, manoeuvrability, and user-friendly operation. With a built-in, quick release water tank and push-lever trigger, the Ecoshine™ Pro can reach heights of 3.2m.

This innovative tool seamlessly integrates the cleaning power of pure water and microfibre, efficiently removing dirt from windows and non-porous surfaces with rapidity and minimal effort.

## IDEAL FOR

- Partition walls
- Mirrors & showers
- Ground windows
- Shop windows
- Display cabinets
- Public transport windows
- Digital signs

- + **Maximised Pad Grip**
- + **Quick Release Water Tank**
- + **Precision Dial & Pad Axel**
- + **Intergrated Spray Nozzle**



### Precision Dial

Allows the user to set a precise angle to the mop head before cleaning.



### Pad Axels

These pad axels allow for 270° Rotation so you never miss a spot

### Quick Release Water / Solution Tank

### Responsive water Flow Trigger



## 1 System

	ECOSHINE™ PRO		
	<b>0.7</b> Mtr	<b>1.7</b> Mtr	<b>3.6</b> Mtr
	KIT CODE <b>V552090</b>	KIT CODE <b>V552150</b>	KIT CODE <b>V552310</b>
Tank Size	<b>400ml</b>	<b>750ml</b>	<b>750ml</b>
Collapsed Length	<b>800mm</b>	<b>1,190mm</b>	<b>1,960mm</b>
Extended Length	<b>960mm</b>	<b>1,660mm</b>	<b>3,260mm</b>

## 3 Microfibre Pads



**2x Microfibre Scrub Cloths**  
Suitable for cleaning soiled glass and removing light dust.



**2x Microfibre Polishing Mops**  
Efficient cleaning and polishing of high gloss surfaces



# DRAGONFLY® 4

## INTERNAL CLEANING KIT

The Streamline™ Dragonfly® offers an ideal solution for internal glass cleaning, eliminating the need for ladders or other reaching equipment. This innovative tool enables you to clean elevated windows while keeping your feet firmly on the ground. Featuring a straightforward pump system and a backpack filled with pure water or a gentle detergent glass cleaner. Along with a microfiber pad attached to a swivel mop plate, the Dragonfly®4 makes internal window cleaning quicker and easier.

### IDEAL FOR

- Skylights
- Atriums
- Stairwells
- Partition walls
- Mirrors & showers
- Ground windows
- Shop windows
- Display cabinets
- Public transport windows
- Digital signs

### FEATURES

#### Reach high windows safely

Clean windows up to 60ft from the ground, eliminating the need for ladders.

#### Effortless cleaning

Simple pump system and microfiber pad make cleaning quick and easy.

#### Chemical-free shine

Achieve sparkling windows, mirrors, and surfaces without harsh detergents.





### 1 System



Tank Size	1.5ltr
Pump	42psi
Run Time	8hrs
Water Flow	3.8Lpm

Width	Length	Weight
 45cm	 65cm	 921g

### DRAGONFLY®



### THIS KIT INCLUDES

#### 2 Waterfed Pole



Choose any Size from 17ft - 60ft | See Page 14

#### 3 Microfibre Pads

2x Microfibre Scrub Mops  
Suitable for cleaning soiled glass and removing light dust.



2x Microfibre Polishing Mops  
Efficient cleaning and polishing of high gloss surfaces



#### 4 Accessories

Spray Assembly for OVA8®

15mtr Pole Tubing

Spray Remote

Aluminium Mop Plate

Battery Charger + International Plug Attachments



After choosing your kit from the previous pages please select any pole size from the table below to add to your bundle.

**DRAGONFLY® OVA8®**



**FEATURES**  
 These expertly engineered water-fed telescopic poles are perfect for a range of tasks, including window cleaning, maintaining solar panels, and cleaning conservatories. The lightweight and ergonomically designed poles, constructed from carbon fibre, ensure a firm grip even at full height, with zero spin.

**100% Carbon Fibre**

**Zero Pole Spin**

 Super Lightweight

 Quick Release Pole Tubing

Pole Code	Size	No. sections	Storeys	Weight
DRAGONFLY-OV17	17ft / 5.1	5	2	1.1kg
DRAGONFLY-OV25	25ft / 7.7mtr	5	3	1.35kg
DRAGONFLY-OV30	30ft / 9.15mtr	6	3	1.70kg
DRAGONFLY-OV35	35ft / 10.7mtr	7	4	2.0kg
DRAGONFLY-OV40	40ft / 11mtr	8	5	2.50kg
DRAGONFLY-OV45	45ft / 14mtr	9	5	2.80kg
DRAGONFLY-OV60	60ft / 18mtr	10	6	3.80kg





# External Window Cleaning

**External Windows  
Conservatory Windows  
Skylight Windows**

Our external window cleaning kits are the epitome of efficiency and effectiveness in maintaining the exterior clarity of windows. Designed for professionals, these kits feature high-reach OVA8® water-fed poles that enable access to elevated windows with ease. The inclusion of trolley-based pure water systems enhances the portability and convenience of the cleaning process. Ideal for a diverse range of outdoor settings, these kits prove indispensable for cleaning windows on high-rise buildings, office complexes, residential structures, and more. The OVA8® water-fed poles ensure precision and safety in reaching elevated windows, while the trolley-based pure water systems provide a continuous supply of purified water for streak-free and spotless results.

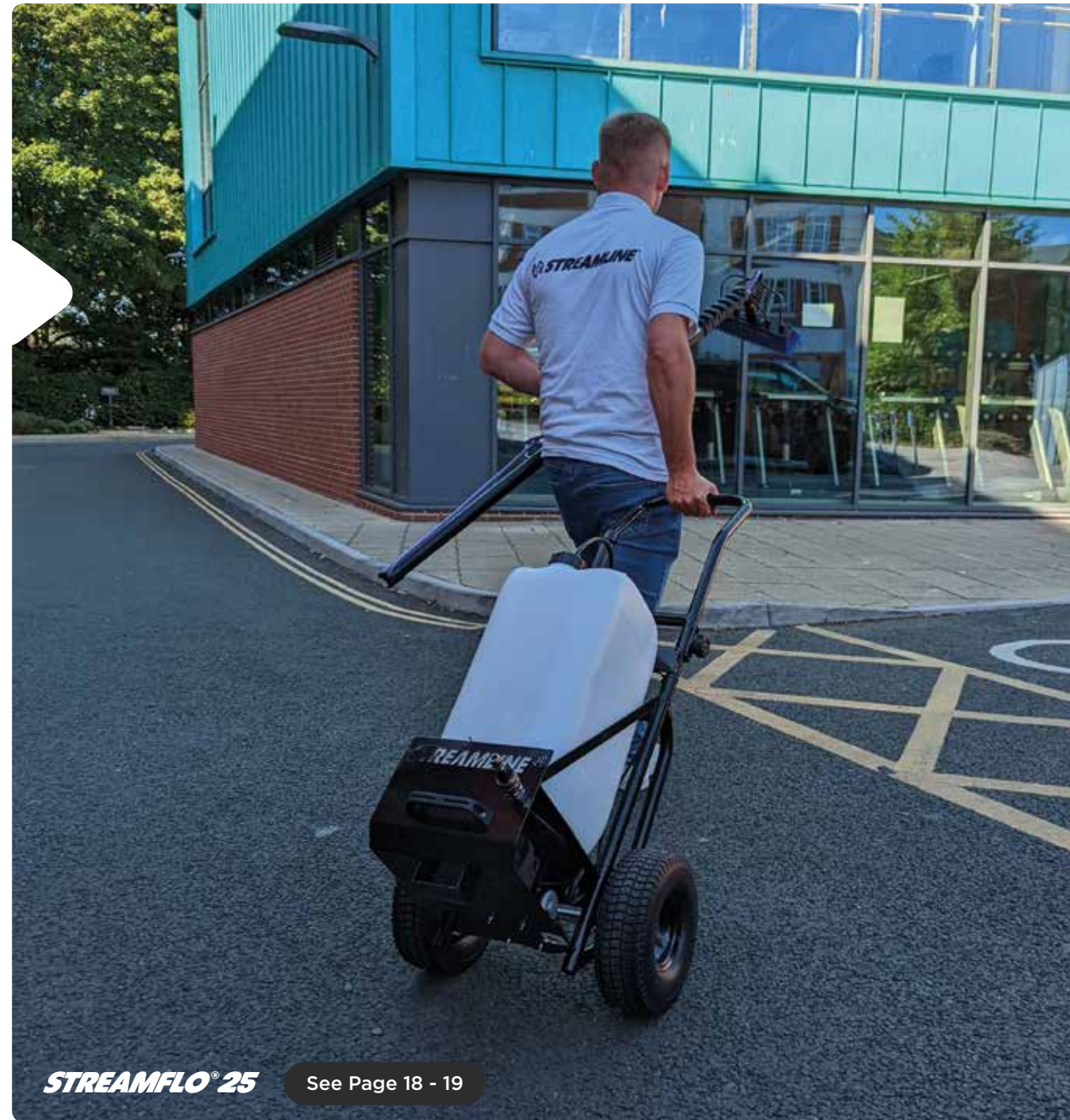

**STREAMFLO® 25** See Page 18 - 19

## Find out your water area type...



TDS Calculator

Our pure water systems employ advanced purification processes such as deionisation and reverse osmosis to eliminate impurities from the water, resulting in a high-quality cleaning agent that ensures flawless, streak-free windows.

By utilising our TDS Calculator, you can determine the TDS level in your area and ascertain whether a pure water system is the optimal solution for your window cleaning requirements.

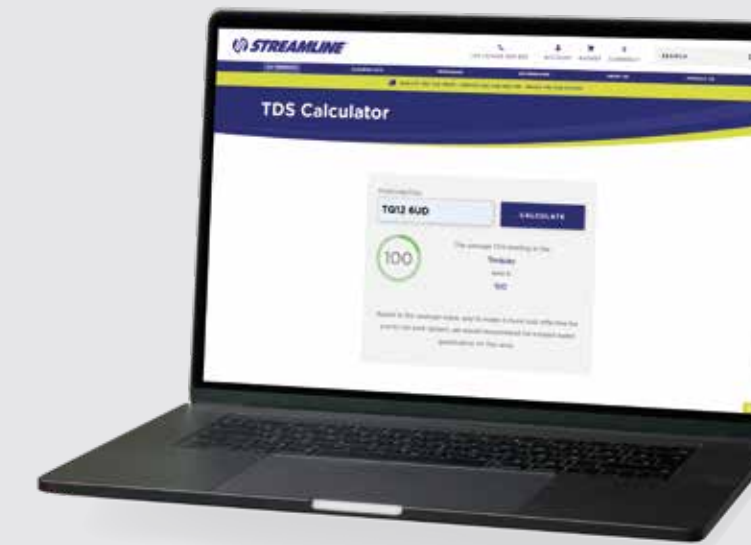

## 01



### Soft Water Areas

These Portable Trolley Systems shine in soft water areas for several reasons. Its powerful pump and V16 controllers ensure efficient flow of water, which is crucial since soft water lacks minerals that aid in cleaning. Additionally, the optional DI filtration system removes any remaining impurities, leaving you with pure water that dries streak-free on your windows. This system eliminates the need for harsh chemicals often used in traditional methods, making it an eco-friendly choice.

See Page 18 - 21

## 02

### Hard Water Areas

For sparkling windows in hard water areas, These RODI Trolley systems are a game-changer. Gone are the days of battling water spots! Its meticulous three-stage filtration, including a reverse osmosis membrane and polishing DI filter, eliminates dissolved minerals, leaving you with ultra-pure water (000ppm) for a streak-free shine. Worried about maintaining quality? The built-in TDS meter provides real-time assurance.



See Page 22 - 27



# STREAMFLO® 25

## EXTERNAL CLEANING KIT

The Streamflo® 25ltr Portable Trolley System is the go-to choice for professional window cleaners and contract cleaners. Featuring a 25ltr container with a powerful 100psi diaphragm pump that guarantees a steady and efficient flow. The compact design, collapsible handles, and lightweight frame with front-mounted handle provide easy storage and handling even in confined spaces. Equipped with a rechargeable Li-ion battery, intelligent charger, and a 5-hour charge time for a 12-hour run-time, it offers efficient operation, lasting up to 2-3 days depending on usage.

The inclusion of a Streamline™ flow controller maximises flow, saving water effectively. For added convenience, the trolley features low-profile flat-free tyres for rough terrain, and a stainless outlet connector with a stop valve to conserve water when disconnected. With optional DI filtration for fast pure water production, a filter cartridge system for quick and easy changes, and a TDS hand-held meter for accurate water quality checks (DI version only), this portable trolley system delivers both specifications and benefits in one comprehensive solution.

### IDEAL FOR

- External Windows
- Atriums
- Cladding
- Conservatory
- Skylights

### SYSTEM FEATURES

- Powerful 100psi diaphragm pump.
- Streamline™ flow controller to maximise flow and save wasting water.
- Compact design, with collapsible handles for storing in confined spaces.
- Lightweight frame with handle mounted on the front plate, for easy lifting and handling.
- Low profile flat-free tyres, for rough terrain.



### 1 System



Tank Size	25ltr
Filtration	DI
Pump	100psi
Run Time	12hrs

Height	Width	Length	Weight
115cm	45cm	65cm	31kg

Water Area Range 0 - 150ppm

# STREAMFLO® 25

THIS KIT INCLUDES

### 2 Waterfed Pole

Streamline™ OVA8® Carbon Fibre Waterfed Pole



Choose any Size from 17ft - 60ft | See Page 28

### 3 Brush

Streamline® Brush Medium Dual Bristle V2 OVA8® Swivel Socket



### 4 Accessories

6mm Microbore Hose Complete with Q21FH-6 & AHA.H6 Fittings



Nozzle Jet Kit Pair of each Pencil & Fan Jets



V13 Control water flow speeds directly for tougher dirt

Compact design, with collapsible handle for storing in confined areas.





# STREAMFLO® 120

## EXTERNAL CLEANING KIT

Featuring a compact and robust frame, the Streamflo® 120 barrow kit ensures durability and reliability, effectively removing up to 98% of dissolved impurities from the water. The 100psi pump powers a high flow rate of up to 1200 gallons per day, enabling quick and efficient production of a large volume of pure water for demanding cleaning applications.

Perfect for on-site cleaning of windows, gutters, fasciae, and cladding in schools, colleges, shopping centres, and business parks. The purpose-built 120ltr profile water tank is mounted on a stable two-wheel trolley with large flat-free tyres. The inclusion of the Streambox powerpack, featuring a 100psi pump, Lithium-Ion battery, and controller, adds versatility to this comprehensive system, making it portable, easy to use, and adaptable to various cleaning scenarios.

### IDEAL FOR

- External Windows
- Atriums
- Cladding
- Conservatory
- Skylights



### 1 System



Tank Size	120ltr
Filtration	DI
Pump	100psi
Run Time	12hrs

---

Height	Width	Length	Weight
 115cm	 115cm	 115cm	 115cm

Water Area Range 0 - 150ppm

# STREAMFLO® 120

50mtr Hi-Viz Hose Reel



Easily Accessible Pump & Battery



THIS KIT INCLUDES

### 2 Waterfed Pole



Streamline™ OVA8® Carbon Fibre Waterfed Pole

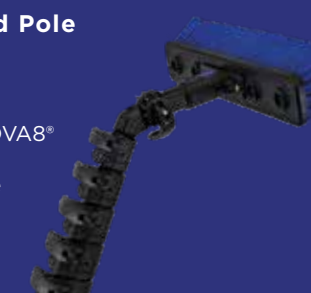

Choose any Size from 17ft - 60ft | See Page 28

### 3 Brush

Streamline™ Brush Medium Dual Bristle V2 OVA8® Swivel Socket



### 4 Accessories

6mm Microbore Hose Complete with Q21FH-6 & AHA.H6 Fittings



Nozzle Jet Kit Pair of each Pencil & Fan Jets





# MOBI MIDGET

## EXTERNAL CLEANING KIT

Crafted with the needs of a single operator in mind, this mobile trolley system features a space-efficient stainless-steel frame, allowing for versatile use in both vertical and horizontal positions. The system guarantees instant access to pure water on demand, supported by a pumped unit that ensures a consistent flow and pressure regulation.

The Mobi® Midget 12V Lithium-Ion Battery-Powered RO System boasts an innovative three-stage filtration system, incorporating a carbon block pre-filter, a reverse osmosis membrane, and a polishing DI filter. This meticulous filtration process results in the delivery of clean water with an outstanding purity level of 000ppm.

The inclusion of an Inline Water Quality TDS Meter enables real-time monitoring of water quality, assuring users of the system's capability to maintain high standards. For added convenience, the system includes a mains charger, providing a quick 5-hour charge time for an impressive 8-hour run time. The design also incorporates a built-in USB port, allowing users to charge their mobile devices while on the go. The easy-to-remove battery further facilitates hassle-free recharging, completing the comprehensive features of this advanced RO system.

### IDEAL FOR

- Partition walls
- Mirrors & showers
- Ground windows
- Shop windows
- Display cabinets
- Public transport windows
- Digital signs

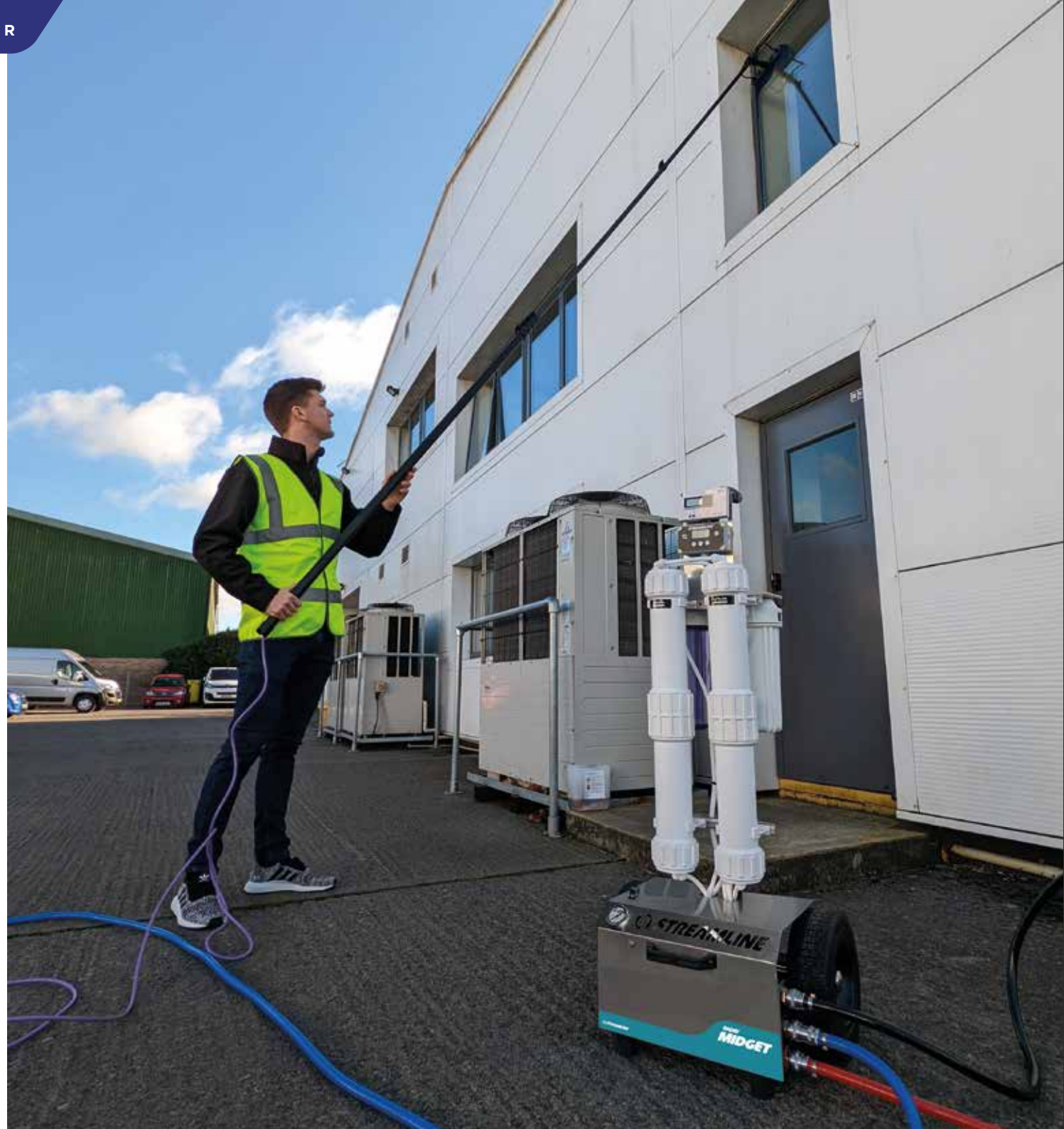

### 1 System



x1

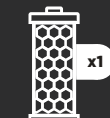

x1

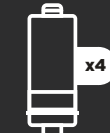

x4



Max Rate	1.8Lpm
Filtration	RODI
Pump	100psi
Membrane Output	1200GPD

Height	Width	Length	Weight
122cm	36cm	48cm	22kg

Water Area Range 0 - 300ppm

# MOBI MIDGET

Esasy access to pumps and internal workings

Quick Change Replacement Filters

Integrated Flush Valve

Removable Battery

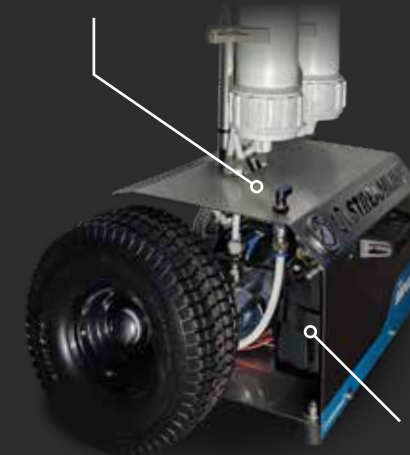

### THIS KIT INCLUDES

#### 2 Waterfed Pole



Streamline™ OVA8® Carbon Fibre Waterfed Pole

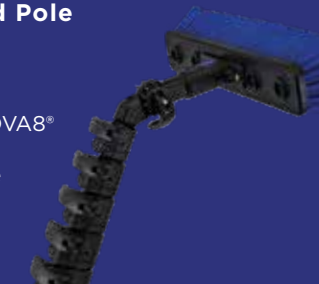

Choose any Size from 17ft - 60ft | See Page 28

#### 3 Brush

Streamline™ Brush Medium Dual Bristle V2 OVA8® Swivel Socket



#### 4 Accessories

Streamline™ Stainless Steel Hose Reel - HRM4-SS



6mm Microbore Hose Complete with Q21FH-6 & AHA.H6 Fittings



Nozzle Jet Kit Pair of each Pencil & Fan Jets



Hose Connections Inlet, Outlets & Waste Water Ports





# MOBI® MEDIAN

## EXTERNAL CLEANING KIT

The Mobi® Median is a portable water purification system which is perfect for window cleaning, courtyards, solar panel cleaning, shopping centers, and schools. To extend the membrane's lifespan and prevent streaks, the Mobi® Median has a convenient flush valve which eliminates contaminants such as sediment and bacteria.

Equipped with a powerful pump and larger filters, the system ensures robust filtration, ultimately saving time and money by reducing the frequency of filter changes. Its high water flow rate means a large amount of water can be processed and delivered in a short amount of time, making it particularly well-suited for cleaning expansive areas and tackling stubborn dirt. Portable and mains powered, the Mobi® Median is a powerful and practical pure water delivery system.

### Integrated Flush Valve

A flush valve allows for flushing the membranes in the system extending the life of the RO membranes by removing contaminants such as sediment, rust and bacteria. This can help to reduce the risk of streaks and spots on windows and solar panels. We recommend flushing your RO membrane every 2-3 months.

### Higher Pump Performance & Bigger Filters

Save time and money in the long run with increased filtration capacity allowing for longer filtration cycles and reduced filter changes. With an increased water flow rate a high-performance pump can also deliver water at a higher flow rate, which can be beneficial for cleaning larger areas or for cleaning windows with heavy dirt or grime.

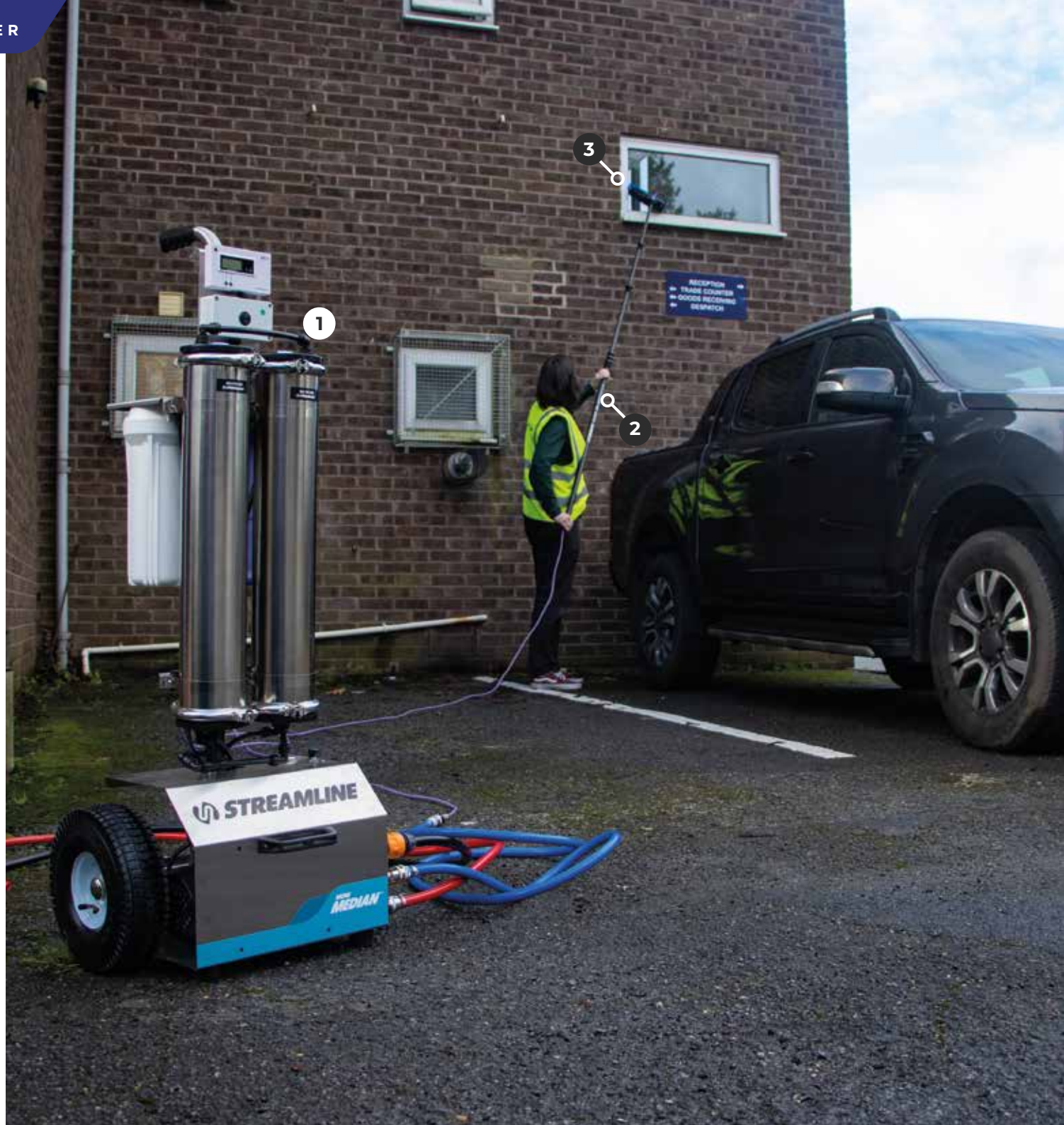

### 1 System

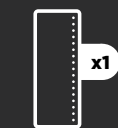

Sediment Filter

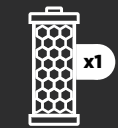

Carbon Block Filter

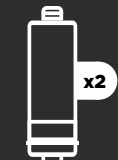

4021 RO Membranes



## MOBI® MEDIAN



Quick Change Replacement Filters

Inlet Outlet Water Ports



Max Rate	2.2Lpm		
Filtration	RODI		
Pump	100psi		
Membrane Output	1800GPD		
-----			
Height	Width	Length	Weight
120cm	38cm	50cm	35kg
Water Area Range		0 - 300ppm	

### THIS KIT INCLUDES

#### 2 Waterfed Pole

Streamline™ OVA8® Carbon Fibre Waterfed Pole



Choose any Size from 17ft - 60ft | See Page 28

#### 3 Brush

Streamline® Brush Medium Dual Bristle V2 OVA8® Swivel Socket



#### 4 Accessories

Streamline™ Stainless Steel Hose Reel - HRM4-SS



6mm Microbore Hose Complete with Q21FH-6 & AHA.H6 Fittings



Nozzle Jet Kit Pair of each Pencil & Fan Jets



Hose Connections Inlet, Outlets & Waste Water Ports





# MOBI® MAXI

## EXTERNAL CLEANING KIT

Crafted from durable stainless steel, the Mobi® Maxi portable filtration system excels as an optimal solution for diverse exterior cleaning applications, including window cleaning, solar panel cleaning, and boat cleaning.

With a remarkable capacity to produce a large volume of pure water the Mobi® Maxi ensures an abundant supply for two operators, both cleaning up to 80ft simultaneously. Its portability and user-friendly design enhance ease of use, allowing for seamless mobility and operation across various cleaning scenarios.

Equipped with an operating pressure gauge and a built-in TDS meter, the Mobi® Maxi provides users with real-time information on water pressure and quality, enhancing control and monitoring during cleaning operations. The comprehensive package includes hose connections and a 5m electrical cable, ensuring users have all the necessary accessories for a hassle-free and complete cleaning solution.

### IDEAL FOR

- Partition walls
- Mirrors & showers
- Ground windows
- Shop windows
- Display cabinets
- Public transport windows
- Digital signs



### 1 System



Sediment Filter



Carbon Block Filter



4040 RO Membranes



DI Vessel



Operators	2
Filtration	RODI
Pump	100psi
Max Rate	9Lpm

Height	Width	Length	Weight
134cm	45cm	60cm	58kg

Water Area Range 0 - 300ppm

# MOBI® MAXI

RO Membrane Access



inline TDS3

Pressure Gauge

Inlet Outlet Water Ports



### THIS KIT INCLUDES

#### 2 Waterfed Pole



Streamline® OVA8® Carbon Fibre Waterfed Pole

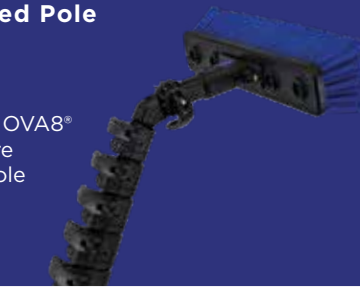

Choose any Size from 17ft - 60ft | See Page 28

#### 3 Brush

Streamline® Brush Medium Dual Bristle V2 OVA8® Swivel Socket



#### 4 Accessories

6mm Microbore Hose Complete with Q21FH-6 & AHA.H6 Fittings



Nozzle Jet Kit Pair of each Pencil & Fan Jets



Hose Connections Inlet, Outlets & Waste Water Ports





OVA8®



FEATURES

These professionally designed, water fed telescopic poles are ideal for window cleaning, cleaning solar panels, and cleaning conservatories. The lightweight, carbon fibre, ergonomically designed pole allows for a sturdy hand-held window cleaning pole – even at full height.

**100% Carbon Fibre**

**Zero Pole Spin**

**Roof Scraper Ready**

 Super Lightweight

 Quick Release OVA8 Attachments

INCLUDED POLE ATTACHMENTS

Flexi-5™ Pole Tubing



Nozzle Jet Kit  
Pair of each  
Pencil & Fan Jets



OVA8® Brush Socket  
90 degree



OPTIONAL EXTRA

OVA8® Dual Angle Adapter

Effortlessly attach 2 OVA8 Accessories to your pole.

**OV-AD20-10**



Univalve

Control your water usage with a waterfed pole.

**AT0002**



Pole Code	Size	No. sections	Storeys	Weight
OV14-24-E	8.5ft / 2.6mtr	5	1	0.63kg
OV17-24-E	17ft / 5.1mtr	5	2	0.99kg
OV22-24-E	22ft / 6.7mtr	6	3	1.35kg
OV25-24-E	25ft / 7.7mtr	7	3	1.35kg
OV22-24-E-HIMOD	22ft / 6.7mtr	7	5	1.05kg
OV30-24-E	30ft / 7.7mtr	8	4	1.70kg
OV35-30-E	35ft / 10.7mtr	7	4	2.00kg
OV40-30-E	40ft / 12.4mtr	8	5	2.50kg
OV45-30-E	45ft / 12.7mtr	9	5	2.80kg
OV60-40-E	60ft / 18.2mtr	10	6	3.80kg

After choosing your kit from the previous pages please select any pole size from the table below to add to your bundle.



# Frequently Asked Questions

## What is Hi-Mod?

OVA8® 22ft Poles come in both standard and HI-MOD variants, while you can still get the same super lightweight, 100% carbon zero spin features with a standard option, HI-MOD offers increased rigidity, a higher grade carbon and a further reduction in weight compared to standard OVA8®

## What is a Univalve?

Univalves are the most convenient way to control your water usage with a waterfed pole. If equipped the operator can simply pull the pole tubing at the base of the pole to stop the flow of water. Saving countless litres of valuable pure water from your system so you have more saved for the next job.

## What is a Angle Adapter?

Specifically designed for the OVA8® this adapter allows for many attachments as well as your brush. You can also adjust the angle of the brush through this attachment so you can always get the most out your cleaning.



# Roof & Render Cleaning

**Moss Removal**  
**Soft Washing**  
**High Pressure Cleaning**

Streamline™ equipment provides solutions for various cleaning needs. High pressure washing kits efficiently remove dirt, grime, mold, and even paint from surfaces like roofs and sidings. However, delicate surfaces require caution with the right nozzle and pressure setting. Moss removal tackles moss buildup, which can harm surfaces and foster mold growth, using methods like high pressure washing or moss killers.

Softwashing offers a gentler approach, using low-pressure water and mild detergents to clean without damaging delicate surfaces. These methods enhance curb appeal, improve air quality, extend surface lifespan, reduce damage risks, require less time and effort, and are environmentally friendly. Choosing the best method depends on surface type, dirt severity, and budget constraints.

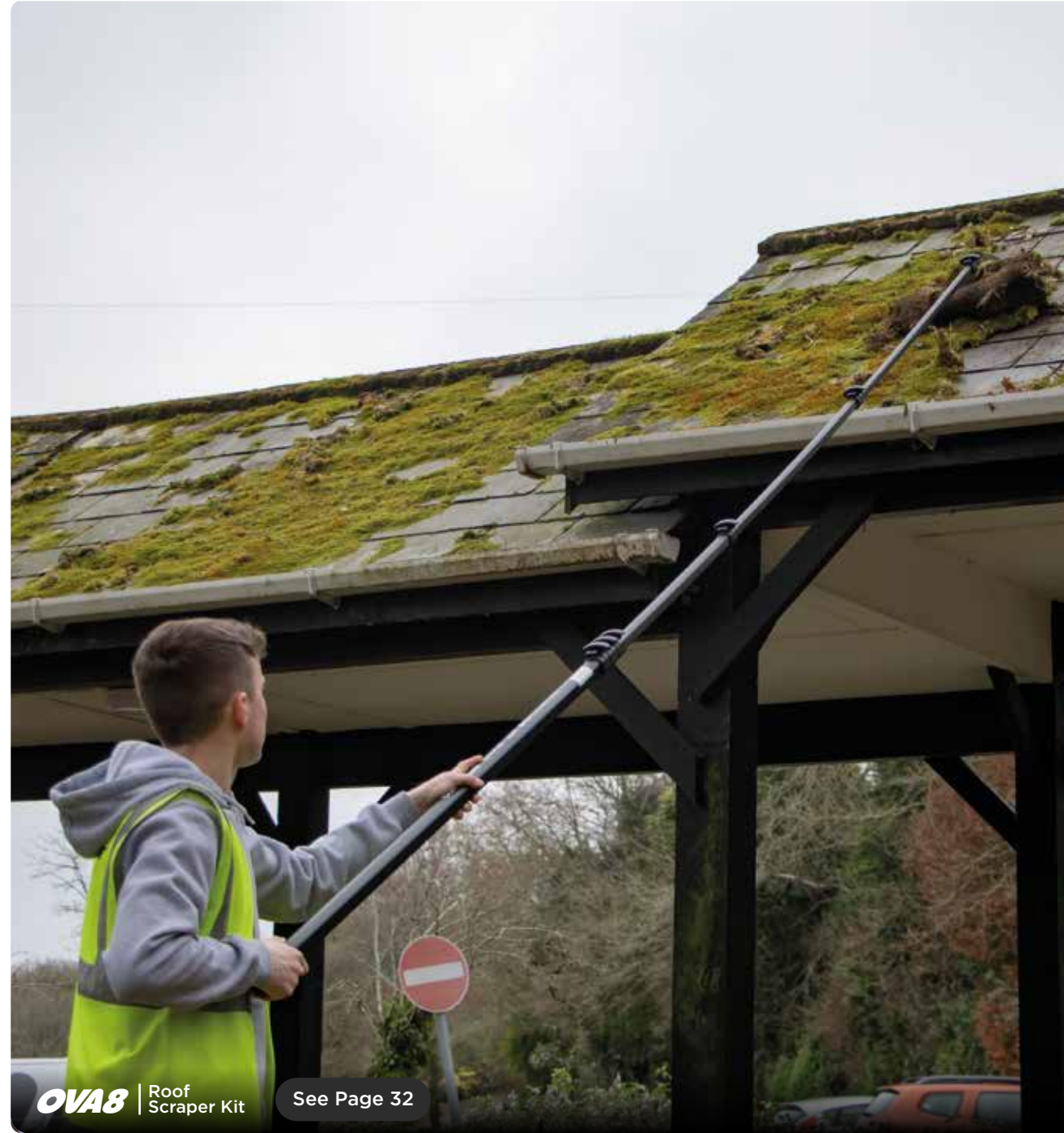

**OVA8** | Roof Scraper Kit

See Page 32

## Tackle Roof Moss Render Grime With Ease.

Stubborn moss on your roof and unsightly grime on your render? We've got the tools for the job! Our introduction to roof and render cleaning highlights two specialised solutions:

### Effortless Moss Removal:

Introducing the lightweight and compact roof scraper attachment for the Streamline® OVA8® pole. Featuring a quick-change head with different blades for various roof tile types, this stainless-steel marvel makes scraping moss and debris a breeze.

### Precise Algoclear Application:

For efficient chemical application, choose either the Softclean™ Mini or Softclean™ Dose. The Mini offers portable Algoclear dosing without electricity, while the Mobile Unit features a booster pump for accurate mixing and pre-set concentration control. Both feature stainless-steel construction and are perfect for spaces like vans and trailers.

**01** ROOF SCRAPING

See Page 32 - 33

**02** SOFTWASHING

See Page 34 - 37

HIGH PRESSURE ROOF CLEANING

See Page 38 - 39

FASCIA CLEANING

See Page 40 - 41



## OVA8® | Roof Scraper Kit

A lightweight and compact roof scraper for moss removal. This attachment, for the telescopic Streamline™ OVA8® pole, incorporates a quick-change head with a load and lock feature.

This feature allows the user to swap out the blades when changing to a new roof tile type. Made from stainless-steel, the roof scraper and blades are rust resistant and extremely durable, and are designed as a specialist roof and moss cleaner for professionals. Consisting of a variety of different blades to suit most roof tiles, the kit allows you to scrape moss and debris off a roof with ease.

### FEATURES

- Attachable to all OVA8® poles.
- Lightweight & compact design.
- Easy locking mechanism when switching in-between blade types.
- Kit comes with 8 different blade profiles for a range of roof tiles.
- Combined with OVA8® angle adapter, you can easily adjust the angle to perfectly suit the roof allowing you to clean roof windows and other hard to reach areas.
- Robust / extremely durable blades made from stainless steel.

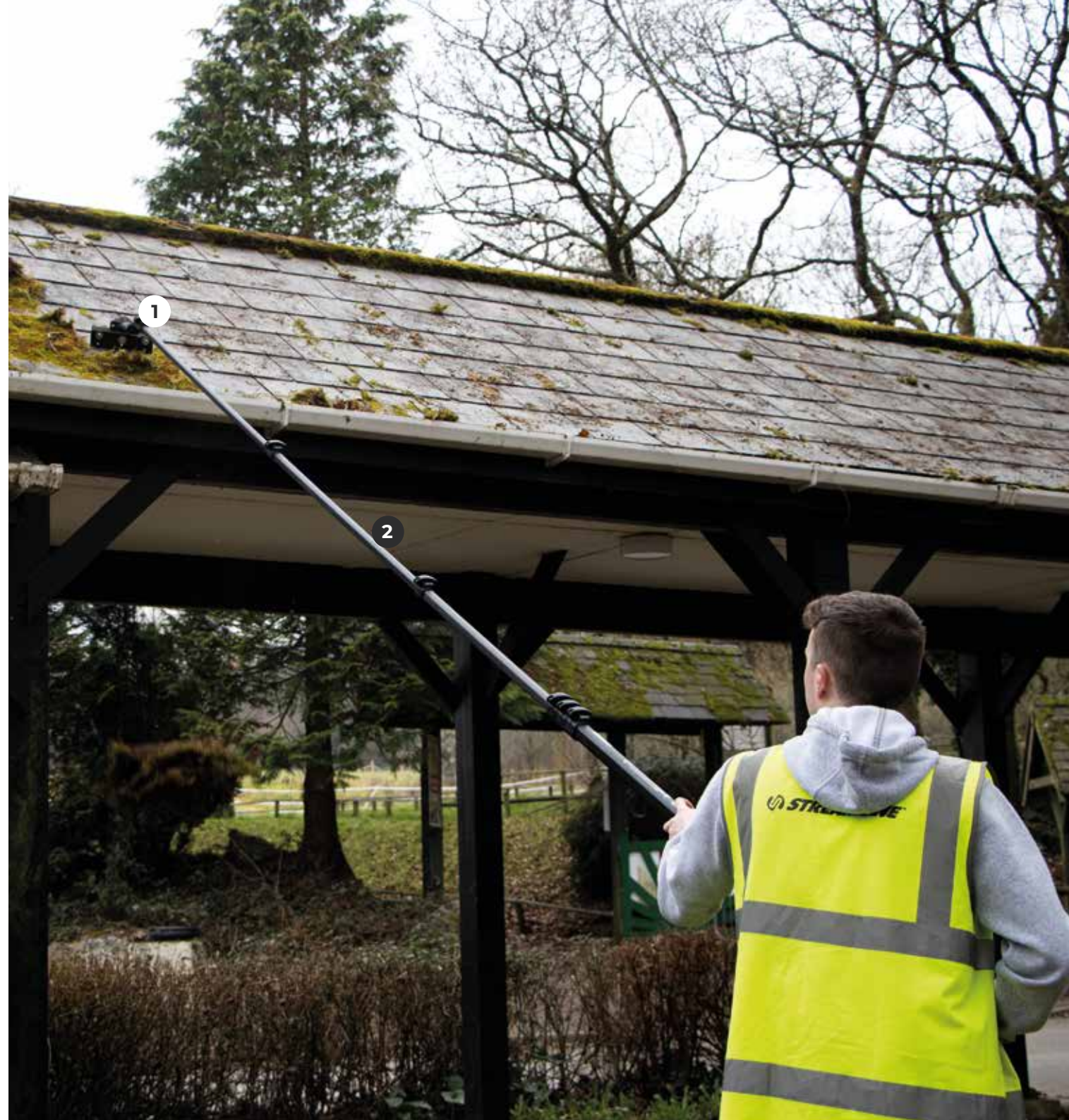

### 1 System

OVA8 | Roof Scraper Kit



Material	Stainless Steel
Blade Types	8
Attachment	OVA8 Quick Release

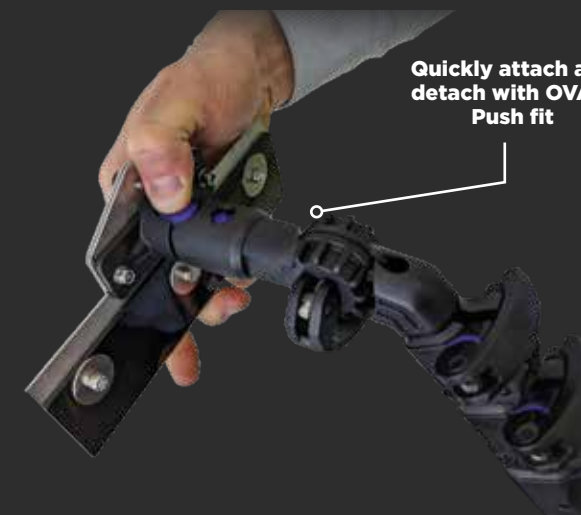

### ROOF BLADE TYPES



Flat Blade Type



Ludlow Plus

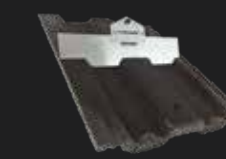

Marley Ludlow Major



Marley Mendip

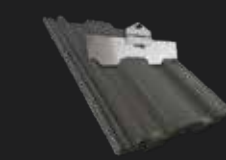

Redland Renown



Redland Regency



Roman Double

### THIS KIT INCLUDES

#### 2 Scraping Pole

OVA8®

Streamline® OVA8® Carbon Fibre Pole

Pole Code	Size	No. sections	Weight
OV17-24-E	17ft / 5.1mtr	5	1.35kg
OV22-24-E	22ft / 6.7mtr	6	1.70kg
OV25-24-E	25ft / 7.7mtr	5	2.00kg
OV30-24-E	30ft / 7.7mtr	6	2.50kg

#### 3 Roof Scraper Blades

x8 Roof Scraper Blades





# SOFTCLEAN™ Mini

## SOFT WASHING KIT

Softclean™ Mini offers a highly portable and efficient solution for applying Algoclear to large areas. The chemical injection trolley features a compact dosatron system that can carry up to 10Ltrs of Algoclear. Its mobility allows for precise dosing, connecting to tap water at the user's desired ratio without the need for electricity. The dosatron system, powered by water pressure, ensures accurate application of Algoclear to the target area.

Additionally, the trolley is easy to use and maintain, with a collapsible design for convenient storage, a telescopic handle, and stainless-steel frames. This makes it perfect for use in space-limited areas, such as vans and trailers, providing a versatile and portable solution for effective Algoclear application.

### SYSTEM FEATURES

- Portable dosing trolley
- Easy to store with a collapsible design
- Stainless steel frames
- Pressure release safety valve
- Carries 10Ltrs of Algoclear (Not Included)



Cleaning Jolithus Algae

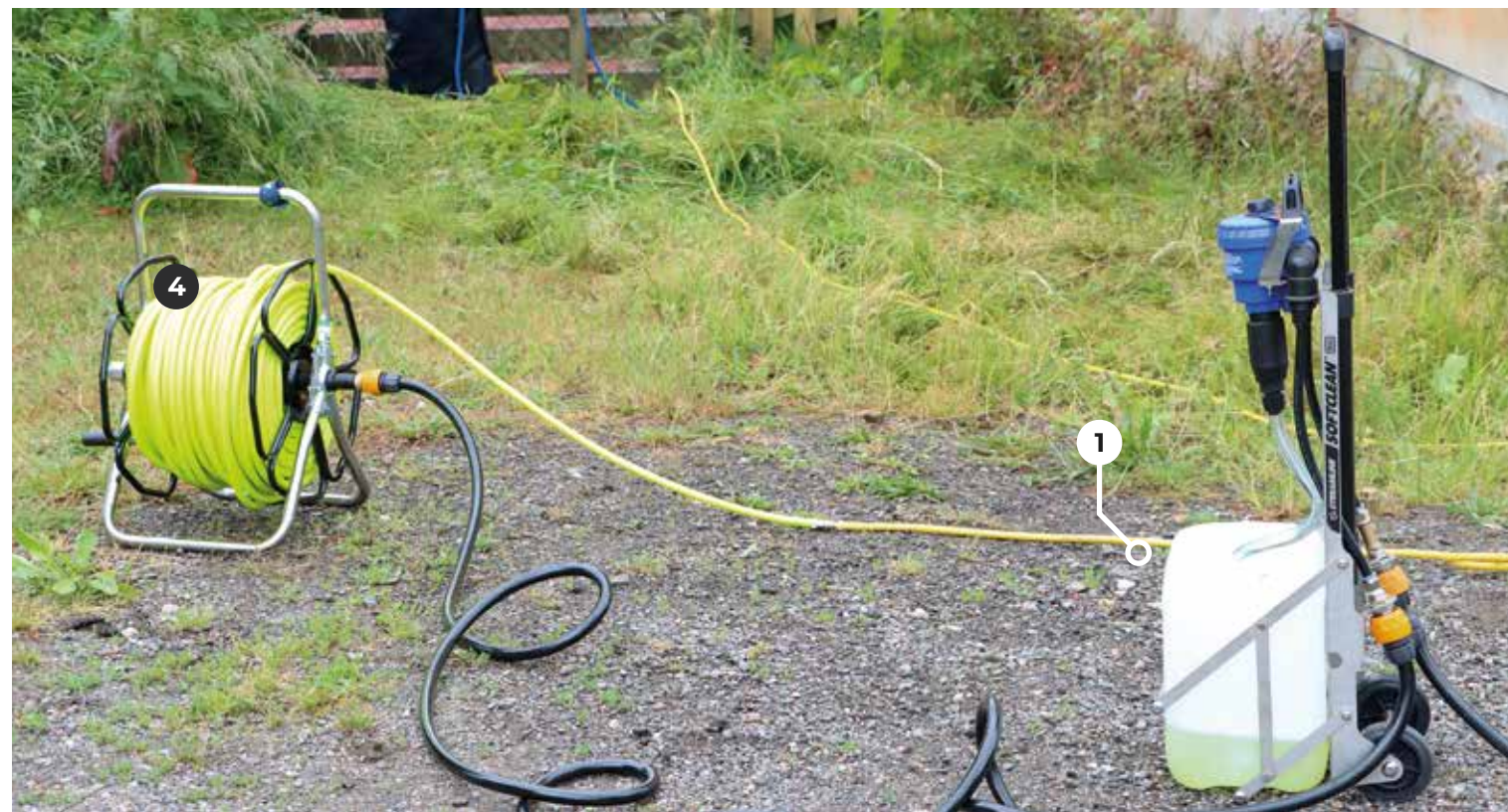

### 1 System



Tank Size	10ltr
Run Time	Constant
External Injection Rate	0.15-8.75%
Max. Viscosity Of Concentrate	400cSt at 20°c

Height	Width	Length	Weight
733mm	270mm	320mm	5kg

### SOFTCLEAN™ Mini

- ✓ **Live Biofilms**  
Moss, lichen, bacteria, algae, yeasts, protozoa, and other microorganisms.
- ✓ **Metabolites**  
Commonly red - from an algae or black from a fungi.
- ✓ **Metallic Marks**  
Iron browning near the ground, rust marks, lead oxide or carbonate. etc
- ✓ **Atmospheric pollution & efflorescence**  
Calcium deposits and surface degradation of stone in the presence of pollutants. Carbon deposits.

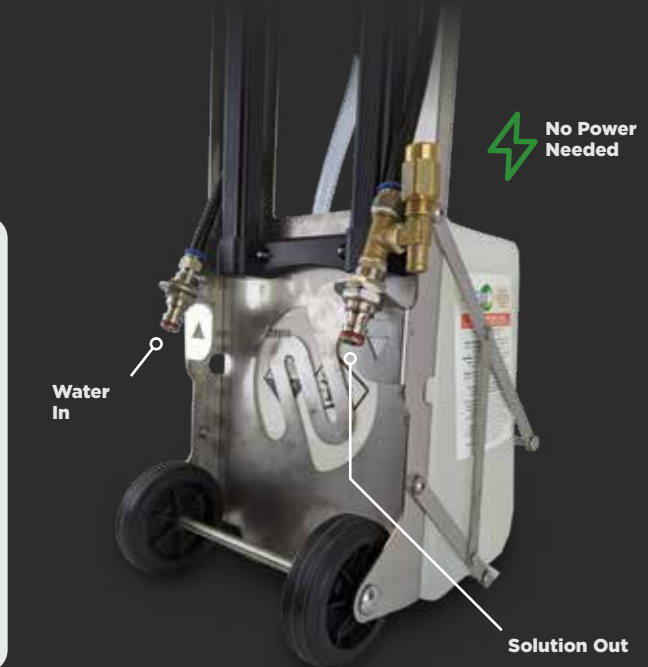

### THIS KIT INCLUDES

#### 2 Softwash Pole

Softclean™ Pole  
With 2-nozzle Low Pressure Manifold



Choose any Size from 17ft - 60ft See Page 42

#### 3 Brush

14" Streamline® Brush  
With 2-nozzle Low Pressure Manifold



#### 4 Hose Reel

Stainless Metal Hose Reel  
50mtr of 12mm Hi-Viz Extraflex Hose



### OPTIONAL EXTRA

#### Softclean™ Pole Angle Adapter for Roof Scraping

Effortlessly attach Roof Scrapers and Roof Cleaning Brushes to your Softclean™ Softwash pole with this easily applicable adapter



AD-SWK001



# SOFTCLEAN™ DOSE

## SOFT WASHING KIT

The Softclean™ Mobile Dosing Unit with Booster Pump is a stainless steel softwash trolley designed for precise chemical dosing. It efficiently mixes AlgoClear (or similar) with water at a pre-set ratio on demand, ensuring accurate concentration application. The unit connects to a water source for versatile chemical mixing either via the pump or directly through the Dosatron trolley. With holders for two 5L chemical containers, it is not suitable for Sodium Hypochlorite use. This portable and durable unit, with holders for two 5Ltr chemical containers mounted on a stainless-steel trolley.

### IDEAL FOR





- Roof Cleaning
- Render Cleaning
- Patio & Driveway Cleaning
- Decking Cleaning
- Exterior Wall Cleaning



### 1 System



Tank Size	2x 10ltr
Run Time	12hrs
External Injection Rate	0.15-8.75%
Max. Viscosity Of Concentrate	400cSt at 20 °c

Height	Width	Length	Weight
			
733mm	270mm	320mm	16.5kg

## SOFTCLEAN™ DOSE

- ✓ Live Biofilms
- ✓ Metallic Marks
- ✓ Metabolites
- ✓ Atmospheric pollution & efflorescence

### V16 Controller



Quick release hoeslock-type inlet & outlet connections



### THIS KIT INCLUDES

#### 2 Softwash Pole

Softclean™ Pole With 2-nozzle Low Pressure Manifold



Choose any Size from 17ft - 60ft See Page 42

#### 3 Brush

14" Streamline® Brush With 2-nozzle Low Pressure Manifold



#### 4 Hose Reel

Stainless Metal Hose Reel 50mtr of 12mm Hi-Viz Extraflex Hose



### OPTIONAL EXTRA

#### Softclean™ Pole Angle Adapter for Roof Scraping

Effortlessly attach Roof Scrapers and Roof Cleaning Brushes to your Softclean™ Softwash pole with this easily applicable adapter



AD-SWK001



# HIGHLINE™ 150

## HIGH PRESSURE ROOF CLEANING

This versatile and rugged workhorse is designed to tackle demanding outdoor tasks efficiently. Equipped with a reliable Honda GX160 petrol engine and an Interpump triple plunger pump, it excels in commercial applications such as gutter cleaning, cladding, wall surfaces, signs, decking, patios, paths, and driveways. The compact trolley, featuring 10" flat-free wheels, ensures easy transportation to and from the site.

The machine's industrial-grade components, including a 36" heavy-duty steel chrome single lance, a 10m high-pressure twin wire rubber hose, and a chemical injector on the unloader, make it a dependable choice for day-to-day commercial use. With a variety of nozzles and robust construction, this machine guarantees smooth and reliable operation in any situation.

### SYSTEM FEATURES

- GX160 Honda engine, recoil start
- Interpump triple plunger pump with built-in unloader valve - for smooth and reliable operation
- 36" Heavy duty steel chrome single lance with quick connector - for easy nozzle changes
- 10mtr High pressure twin wire rubber hose for industrial use and longevity
- 3mtr 19mm Suction hose with weighted filter attached - for drawing from a sump
- Chemical injector on unloader with small filter attached - for drawing in detergents
- Assortment of 5 different nozzles, 15deg, 25deg, 40deg, pencil and foaming tips - for every eventuality
- Heavy duty metal trolley with 10" flat-free wheels - for robustness and great manoeuvrability.



## Clean Houses From Roof to Walls, Down To Driveways.

The roof on the left has been cleaned with a 12" Handheld Surface Cleaner attached to the end of an OVA8® Power Pole

HP-HSC300-QR



### 1 System

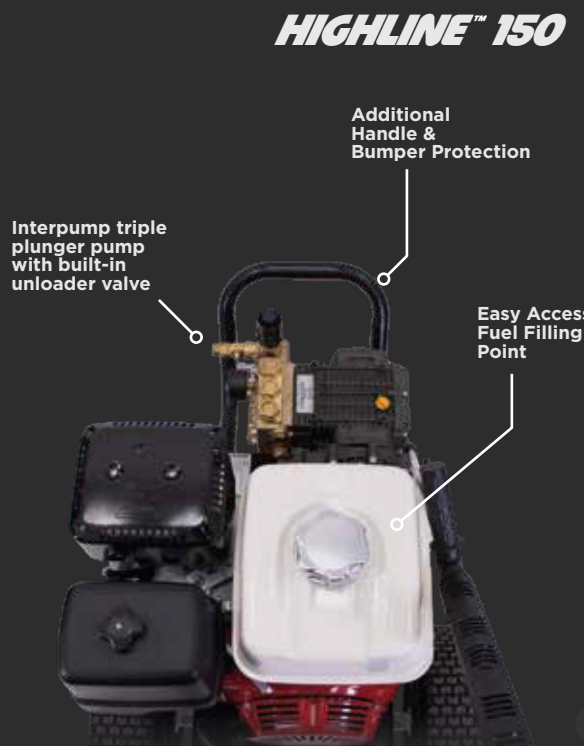

### HIGHLINE™ 150

THIS KIT INCLUDES

### 2 High Pressure Pole



Choose any Size from 17ft - 60ft See Page 43

Max. Water Pressure

276Bar

Max. Temperature Rating

100°C

Clean Up To

42ft

### OPTIONAL EXTRA



12" Handheld Surface Cleaner  
1/4 inch M Quick Release Coupler

HP-HSC300-QR



POWER POLE  
Compatible



Rated PSI

3500Psi

Max. Temperature Rating

82°C

Weight

3kg



Engine	Honda GX160
Max Rated Pressure	150Bar / 2175Psi
Max Rated Flow	12Lpm
Max Rated Temp	60°C

Height	Width	Length	Weight
90cm	55cm	85cm	45.2kg



# STREAMFLO® 25

## FACIA CLEANING KIT

Your perfect solution for mobile water delivery and pristine fascia cleaning. The Streamflo® 25Ltr Trolley System ensures pure water on demand, just fill the container with tap water, and it produces 0 ppm pure water instantly. Tailored for the most demanding tasks, it's an ideal choice for professional window cleaners, contract cleaners, shopping centres, hotels, schools, hospitals, nursing homes, public houses, and clubs.

Benefit from a full day's use (12 hours) with a quick 5-hour recharge time. The system boasts a max flow of 1700gpd (4.5ltrs per minute) at 100psi, and its digital flow controller allows for customizable pump speed, enabling water conservation. The Streamflo™ 25 trolley system includes all the essential tools for efficient waterfed pole fascia cleaning.

### SYSTEM FEATURES

- Powerful 100psi diaphragm pump.
- Streamline® flow controller to maximise flow and save wasting water.
- Compact design, with collapsible handle for storing in confined spaces.
- Lightweight frame with handle mounted on the front plate, for easy lifting and handling.
- Low profile flat-free tyres, for rough terrain.



### 1 System

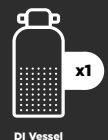

x1



Operators	1
Tank Size	25ltr
Filtration	DI
Pump	100psi
Run Time	12hrs

Height	Width	Length	Weight
115cm	45cm	65cm	31kg

Water Area Range 0 - 150ppm

# STREAMFLO™ 25

Compact design, with collapsible handles for storing in confined areas.



Easily detachable DI filter for quick resin changes

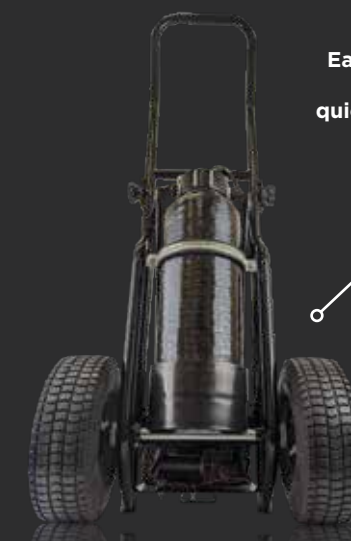

THIS KIT INCLUDES

### 2 Waterfed Pole

OVA8®



Choose any Size from 17ft - 60ft | See Page 44

### 3 Brush

Streamline® Brush Medium Dual Bristle V2 OVA8® Swivel Socket

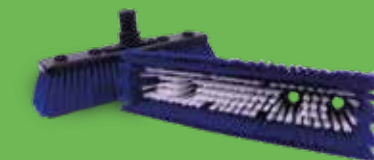

Brush Weight  
From 289g

Bristle Material  
Nylon

Jet Pass Throughs  
2 - 4

### 4 Accessories

Nozzle Jet Kit  
Pair of each  
Pencil & Fan Jets





**SOFTCLEAN™** | Pole



AVAILABLE IN 6 SIZES

Pole Code	Height	No. sections	Material
SW-PK007	22ft / 6.7mtr	5	Hybrid
SW-PK008	26ft / 7.9mtr	6	Hybrid
SW-PK009	30ft / 9.1mtr	7	100% Carbon
SW-PK010	33ft / 10.2mtr	8	100% Carbon
SW-PK011	36ft / 11.0mtr	9	100% Carbon
SW-PK012	40ft / 12.4mtr	10	100% Carbon



FEATURES

The Softclean™ Pole Kit Complete is a premium softwash pole kit with a variety of extra features, including a hidden hose angle adapter, a single large fanjet nozzle, front facing horizontal clamps, and an easy to use shutoff valve at the bottom of the pole.

The hidden hose angle adapter is a unique feature that ensures the hose stays inside of the pole even if a brush is attached. This prevents the hose from getting tangled or damaged, and it also makes the pole easier to maneuver.

The single large fanjet nozzle is the perfect nozzle for softwashing applications. It produces a wide, gentle spray that is ideal for applying softwash chemicals to roofs, siding, and other surfaces.

The front facing horizontal clamps are another unique feature of the Softclean™ Pole Kit Complete. These clamps make it easy to attach and remove brushes and other accessories, and they also help to keep the pole stable and secure.

The easy to use shutoff valve at the bottom of the pole allows you to quickly and easily turn off the water flow.

**OVA8® POWER POLE**



AVAILABLE IN 4 SIZES

Pole Code	Achievable Height	No. sections	Storeys	Weight
HP-OV4-COMP	25ft / 7.62 mtr	4	2	4.28kg
HP-OV5-COMP	29ft / 8.8mtr	5	3	4.62kg
HP-OV6-COMP	33ft / 10mtr	6	4	5.02kg
HP-OV8-COMP	42ft / 12.8mtr	8	5	7.20kg

Max. Water Pressure  
**276Bar**

Max. Temperature Rating  
**100°C**

Clean Up To  
**42ft**

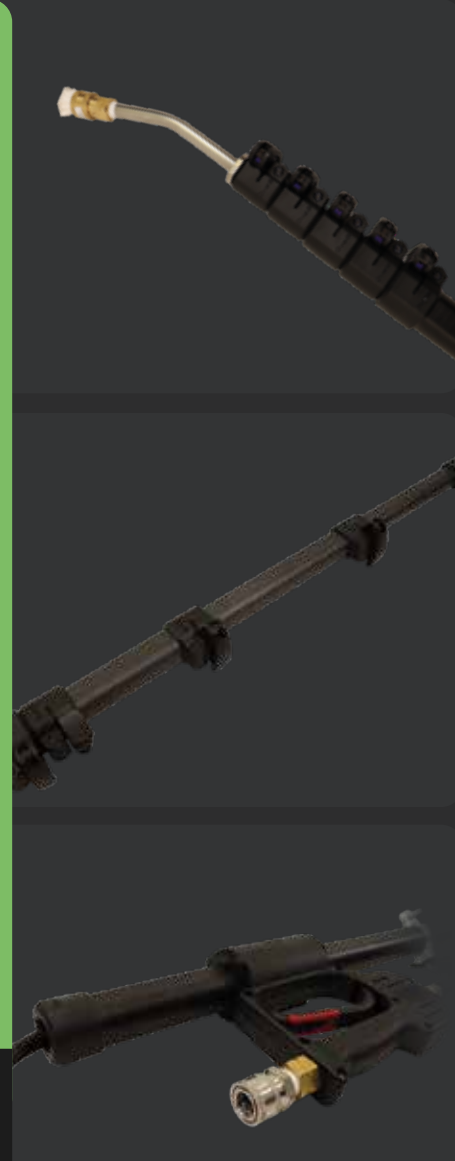

FEATURES

Streamline™ OVA8® High Pressure Power Pole a unique high pressure configuration for the OVA8® Poles enabling users to clean up 42ft with 4000psi 276bar. And because of the anti-spin pole section on the Streamline™ OVA8® pole, the oval shaped clamps work less due to only having to prevent the pole sections from moving up or down. The pole offers more rigidity and better control, as the two flat sides sits more comfortably in an operator's hand and allow the tips of their fingers to sit on the flat edge.

This product is really a cost-effective cleaning solution. It eliminates the need for additional cleaning equipment, such as ladders or scaffolding, which can be costly and time-consuming. Overall, the Streamline® Power Pole is an excellent investment for anyone who needs a reliable and efficient cleaning tool for hard-to-reach areas.

**100% Carbon Fibre**  
*With Glass Fibre Handle\**

**Zero Pole Spin**

Super Lightweight

Quick Release Stainless Fitting



**OVA8®**



AVAILABLE IN 10 SIZES

Pole Code	Size	No. sections	Storeys	Weight
OV14-24-E	8.5ft / 2.6mtr	5	1	0.63kg
OV17-24-E	17ft / 5.1mtr	5	2	0.99kg
OV22-24-E	22ft / 6.7mtr	6	3	1.35kg
OV25-24-E	25ft / 7.7mtr	7	3	1.35kg
OV22-24-E-HIMOD	22ft / 6.7mtr	7	5	1.05kg
OV30-24-E	30ft / 7.7mtr	8	4	1.70kg
OV35-30-E	35ft / 10.7mtr	7	4	2.00kg
OV40-30-E	40ft / 12.4mtr	8	5	2.50kg
OV45-30-E	45ft / 12.7mtr	9	5	2.80kg
OV60-40-E	60ft / 18.2mtr	10	6	3.80kg

**FEATURES**

These professionally designed, water fed telescopic poles are ideal for window cleaning, cleaning solar panels, and cleaning conservatories. The lightweight, carbon fibre, ergonomically designed pole allows for a sturdy hand-held window cleaning pole - even at full height.

**100% Carbon Fibre**

**Zero Pole Spin**

**Roof Scraper Ready**

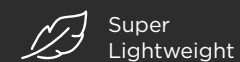

Super Lightweight



Quick Release OVA8® Attachments

**INCLUDED POLE ATTACHMENTS**

Flexi-5™ Pole Tubing



Nozzle Jet Kit  
Pair of each  
Pencil & Fan Jets



OVA8® Brush Socket  
90 degree



**OPTIONAL EXTRA**

OVA8® Dual Angle Adapter

Effortlessly attach 2 OVA8 Accessories to your pole.



OV-AD20-10

Univalve

Control your water usage with a waterfed pole.



AT0002

**OVA8™**



Looking to Clean CCTV Cameras?

See Page 101

**SOFTCLEAN™** | Pole



**OVA8® POWER POLE**





# Gutter Vacuums & Pole Kits

Streamvac™ is the cutting-edge solution for commercial gutter cleaning. Our high-powered gutter clearing system is specifically designed to tackle even the toughest debris build-up in commercial settings. With our state-of-the-art Commercial 30ltr and 70ltr Gutter Cleaning Systems, ranging from 21ft to 38ft, maintaining clean and clog-free gutters has never been easier.



**STREAMVAC™ 70** See Page 50 - 51

## Revolutionise Your Gutter Cleaning with Streamvac™

### Safe & Efficient:

Our system is completely safe to use, even on tall buildings. It eliminates the need for ladders and scaffolding, which can be dangerous and time-consuming.

### Fast & Effective:

Streamvac™ can clean gutters up to 38ft high in just minutes. This saves you time and money, and helps to prevent water damage to your property.

.....

The Streamvac™ 30ltr & 70ltr Gutter Cleaning Kits Offering Industrial performance with twin motors, the 30ltr & 70ltr Streamvac™ is built from stainless steel. With a tiltable and removable container you still have the benefits of easy handling and disposal of contents. There is a washable PET fleece large surface filter for high efficiency and low maintenance costs and a Push & Clean filter cleaning system. The 10mtr cable allows a large working radius and the reliable floating system allows for wet and dry pick up.

**01** **STREAMVAC™ 30**

See Page 48 - 49

**02** **STREAMVAC™ 70**

See Page 50 - 51

**03** **ULTRALITE™** | Pole Kits

Introducing the Ultralite™, the revolutionary gutter vacuum pole designed to make cleaning your gutters a breeze. Crafted from high-strength carbon fiber, the Ultralite™ boasts an incredibly lightweight design at just 51mm in diameter, making it effortless to maneuver and manipulate while also allowing larger clumps of dirt to pass down the pole with ease, even at its full extension of 38ft.

See Page 52 - 53



# STREAMVAC™ 30ltr

The professional power and performance in either mode, wet or dry, to the full TwinFlo specification is exceptional and embodies in a single machine 15 years experience in supplying the commercial market worldwide. The design, construction and performance must be experienced to be believed.

The heavy-duty Structofoam construction with the unique multi-purpose tipper system for emptying, with user-friendly features can be used anywhere and emptied quickly and easily. All machines are wet or dry and the change from one to the other is designed to be simple, exchange a dry filter for wet safety float valve and a change of floor nozzle, or vice versa. There is a choice of one or two-motored models, both of which include the NuCable replaceable cable system as standard. A tool for every job, always on hand and packs neatly away, with professional BS8 accessory kit.

## SYSTEM FEATURES

- Cyclonic inlet for increased air flow performance and non-blocking.
- Virtually indestructible Structofoam drum (Doesn't collapse due to the high suction or dent when loading/unloading out of vehicles.)
- Drum has a dump hose and tipping function for easy emptying.
- Front wheels fitted with locking casters.
- Large rear wheels for easy manoeuvring over rough terrain.
- 7.5mtr crush-proof hose.
- Can be used as a normal vacuum or a blower.



## 1 System



Drum Size	30ltr
Power Supply	110v / 230v
Twin Motor	(x2) 1060w
Airflow	98ltr / sec

Height	Width	Length	Weight
85cm	80cm	49cm	25kg

Built In HEPA filter with easy access to empty dirt.



Secure locks keeping system air tight and dirt safe from leaking out

# STREAMVAC™ 30

## THIS KIT INCLUDES

### 2 ULTRALITE™

	3ft 51mm Ultralite™ modular Base Section carbon fibre pole		
	6ft 51mm Ultralite™ modular Top Section carbon fibre poles		
Pole Material Carbon Fibre	Pole Diameter 51mm	Clean Up To 50ft	Pole Weight From 0.4kg

Choose any Size from 17ft - 60ft | See Page 52

### 3 Tools

	Aluminium Crevice Tool 230-20
	Aluminium Crevice Tool 230-35
	Aluminium Gutter Swan Neck - Male Cuff

### 4 Accessories

	Holdall Streamline designed Ultralite 6x Pole Storage
--	--

### OPTIONAL EXTRA

	CCTV Wireless Bullet Camera & Widescreen Monitor Kit
--	--

See Page 53



# STREAMVAC™ 70ltr

Offering Industrial performance with twin motors, the 70ltr Streamvac™ is built from stainless steel. With a tiltable and removable container you still have the benefits of easy handling and disposal of contents. There is a washable PET fleece large surface filter for high efficiency and low maintenance costs and a Push & Clean filter cleaning system. The 10mtr cable allows a large working radius and the reliable floating system allows for wet and dry pick up.

## SYSTEM FEATURES

- Two motor industrial performance
- Stainless steel tiltable and removable container for easy handling and disposal of contents
- Washable PET Fleece, big surface filter for high efficiency and low maintenance costs
- Push & Clean filter cleaning system for high efficiency
- 10mtr cable for a large working radius
- Robust fleece filter bag standard
- Applicable for wet & dry pick up by reliable floating system





# STREAMVAC™ 70

## 1 System



Drum Size	70ltr
Power Supply	240v
Twin Motor	(x2) 1200w
Airflow	3700ltr / sec
Cable Length	10mtr

Height	Width	Length	Weight
			
115cm	45cm	65cm	31kg

**Push & Clean Filter Cleaning**  
When you block the fitting for the air inlet or the hose and push the filter cleaning button, the surrounding air enters the container, passes through the filter cartridge in the opposite direction. The dirt is blasted off the filter and the suction performance is high once more.



## 2 Gutter Vac Poles

 **3ft 51mm** Ultralite™ modular Base Section carbon fibre pole

 **6ft 51mm** Ultralite™ modular Top Section carbon fibre poles

Pole Material	Pole Diameter	Clean Up To	Pole Weight From
Carbon Fibre	51mm	50ft	0.4kg

Choose any Size from 17ft - 60ft | See Page 52

## THIS KIT INCLUDES

### 3 Tools

 **Aluminium Crevice Tool 230-20**

 **Aluminium Crevice Tool 230-35**

 **Aluminium Gutter Swan Neck - Male Cuff**

### 4 Accessories



**Holdall**  
Streamline designed Ultralite 6x Pole Storage

### OPTIONAL EXTRA



**CCTV Wireless Bullet Camera & Widescreen Monitor Kit**

See Page 53



**ULTRALITE™**



**FEATURES**

Introducing the Ultralite™, the revolutionary gutter vacuum pole designed to make cleaning your gutters a breeze. Crafted from high-strength carbon fiber, the Ultralite™ boasts an incredibly lightweight design at just 51mm in diameter, making it effortless to maneuver and manipulate while also allowing larger clumps of dirt to pass down the pole with ease, even at its full extension of 38ft.

Need to tackle those extra-high gutters? Simply add the optional 3ft or 6ft extension sections to your kit and reach even further with ease.

**100% Carbon Fibre**

**51mm Diameter**

**Ultralite™ Bag Included**



Super Lightweight



Modular Design

Streamvac™	3ft Ultralite™ Sections	6ft Ultralite™ Sections	Achievable Height	Storeys	Total Weight
30ltr	1	3	21ft	2	1.4kg
	1	6	38ft	4	2.6kg
70ltr	1	3	21ft	2	1.4kg
	1	6	38ft	4	2.6kg



**GO HIGHER**

Looking to clean gutters above 38ft?

Add our Ultralite™ Extension sections to your kit and reach heights up to 50ft

**3FT**

51mm Modular Carbon Fibre Half Section

**6FT**

51mm Modular Carbon Fibre Full Section



**+Free Ultralite™ Holdall Bag**

OPTIONAL EXTRA

CCTV-POLE-KIT0003-051

**CCTV Wireless Bullet Camera & Widescreen Monitor Kit**



The CCTV portable wireless inspection camera is a simple and convenient inspection instrument. It can be used to inspect inaccessible places, pipes, gutters etc. and can be used for building and safety inspections.

**Features**

- HD Livestream from the gutters to the screen at the base of the pole up to 100mts.
- Record and take pictures as you clean to replay to your clients or upload to socials.
- Comes with a 32GB SD card
- LED Lights built into camera for cleaning in low light conditions
- Up to 9hrs battery life with continuous use
- All pole attachments to fit both camera and screen included
- Fold out screen shield included so you can work in all weather conditions





# Transport Cleaning

- Yacht Cleaning
- Cargo Ship Cleaning
- Bus & Truck Cleaning
- Train Cleaning
- Bus Stop Cleaning

Offering advanced solutions in high-pressure cleaning technology for a variety of purposes. Our range of pressure washers is versatile, catering to needs like graffiti removal, facade cleaning, vehicle washing, and even the meticulous task of ship and boat cleaning, including hull maintenance. Tailored for diverse sectors such as manufacturing, public services, agriculture, construction, and transport cleaning, our professional-grade pressure washers ensure reliable performance. Count on Streamline™ for practical and effective cleaning solutions across different industries, where our equipment meets the demands of various challenging cleaning tasks, including those related to maritime and transport environments.



**HOTCUBE™ VAN** See Page 90 - 91

**01**

PURE WATER  
YACHT CLEANING

See Page 56 - 59

**02**

HIGH PRESSURE  
CARGO SHIP CLEANING

See Page 60 - 61

**03**

BUS & TRUCK CLEANING  
LOW & HIGH PRESSURE

See Page 62 - 69

**04**

TRAIN CLEANING

See Page 70 - 71

**05**

BUS STOP CLEANING

See Page 72 - 75

**06**

POLE SELECTION

See Page 76 - 79



# MOBI CARRY

## YACHT CLEANING KIT

The Mobi® Carry stands out as an ideal solution for yacht cleaning due to its tailored features. The system produces clean and pure water, ensuring surfaces are left spot-free and streak-free, providing an impeccable finish to your yacht. With a focus on spot-free rinses, the Mobi® Carry guarantees that surfaces remain clean and streak-free after each rinse, contributing to the overall aesthetic appeal of the yacht.

Its durability and long lifespan make it a reliable investment, assuring users that the system will endure for many years, enhancing its cost-effectiveness. Maintenance is simplified with easy resin replacement and system cleaning, ensuring seamless operation over time. Moreover, its portable design facilitates effortless transportation to the point of use or convenient mounting, offering flexibility and ease of use in various boat cleaning scenarios.

### Clean, pure water for cleaning:

The Mobi® Filtration carry produces clean, pure water that is ideal for cleaning. This water will leave your surfaces spot-free and streak-free.

### Spot-free rinses:

The Mobi® Carry produces water that is ideal for spot-free rinses. This means that you can be sure that your surfaces will be clean and free of streaks after you rinse them with the water from this system.

### Long lifespan:

The Mobi® Carry is a durable system that has a long lifespan. This means that you can invest in this system and know that it will last for many years to come.

### Easy to maintain:

The Mobi® Carry is easy to maintain. You can easily change the resin in the system, and you can also clean the system to keep it running smoothly.



## OVA8® Salt Water Corrosion Resistance

Carbon fibre composites are generally corrosion-resistant even in saltwater environments, making them a reliable choice for various applications.

### 1 System



Simple Resin Changes



Quick Fit Water Inlet

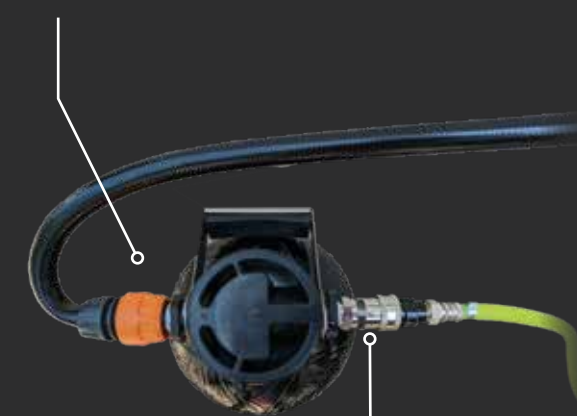

Stop connector on female coupler saving water when disconnected

Operators	1	
Tank Size	6.9ltr	
Filtration	DI	
.....		
Height	Width	Weight
47cm	15cm	14kg
Water Area Range		0 - 150ppm

# MOBI CARRY

## THIS KIT ALSO INCLUDES

### 2 Waterfed Pole

OVA8®

Streamline™ OVA8® Carbon Fibre Waterfed Pole

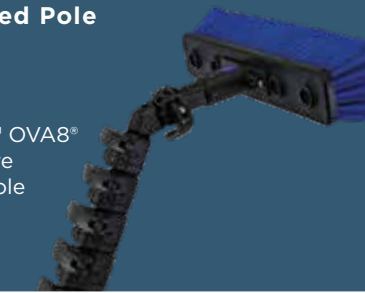

Choose any Size from 14ft - 30ft | See Page 76

### 3 Brush

Streamline™ Hi-Lo Angle Medium Bristle Brush



### 4 Accessories

Nozzle Jet Kit  
Pair of each  
Pencil & Fan Jets



6mm Microbore Hose Complete with Q21FH-6 & AHA.H6 Fittings



Stainless Metal Hose Reel  
50mtr of 12mm Extraflex Hose





# MOBI MEDIAN

## YACHT CLEANING KIT

The Mobi® Median is a portable water purification system which is perfect for window cleaning, courtyards, solar panel cleaning, shopping centers, and schools. To extend the membrane's lifespan and prevent streaks, the Mobi® Median has a convenient flush valve which eliminates contaminants such as sediment and bacteria.

Equipped with a powerful pump and larger membranes, the system ensures robust filtration, ultimately saving time and money by reducing the frequency of membrane changes. Its high water flow rate means a large amount of water can be processed and delivered in a short amount of time, making it particularly well-suited for cleaning expansive areas and tackling stubborn dirt. Portable and mains powered, the Mobi® Median is a powerful and practical pure water delivery system.

### Integrated Flush Valve

A flush valve allows for flushing the membranes in the system extending the life of the RO membranes by removing contaminants such as sediment, rust and bacteria. Which can help to reduce the risk of streaks and spots on windows and solar panels. We recommend flushing your RO membrane every 2-3 months.

### Higher Pump Performance & Bigger Filters

Save time and money in the long run with increased filtration capacity allowing for longer filtration cycles and reduced membrane changes. With an increased water flow rate a high-performance pump can also deliver water at a higher flow rate, which can be beneficial for cleaning larger areas or for cleaning windows with heavy dirt or grime.



### 1 System



DI Cartridge



Carbon Block Filter



4021 RO Membranes



Operators	1
Max Flow	2.5Lpm*
Filtration	RODI
Pump	120psi

Height	Width	Length	Weight
122cm	36.5cm	48cm	22kg

Water Area Range 0 - 300ppm

# MOBI MEDIAN



Quick Change Replacement Filters

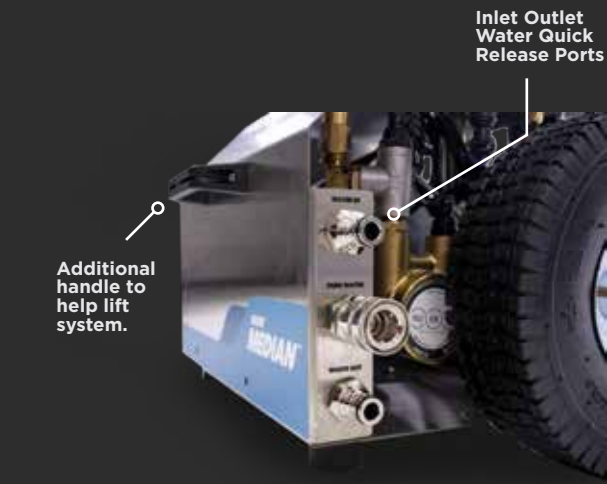

Inlet Outlet Water Quick Release Ports

Additional handle to help lift system.

### THIS KIT ALSO INCLUDES

#### 2 Waterfed Pole

OVA8®

Streamline™ OVA8® Carbon Fibre Waterfed Pole

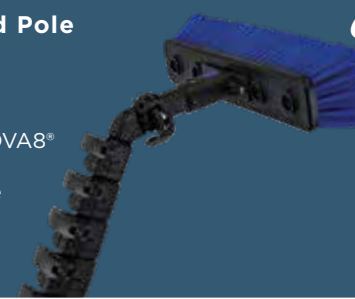

Choose any Size from 14ft - 30ft | See Page 76

#### 3 Brush

Streamline™ Hi-Lo Angle Medium Bristle Brush



#### 4 Accessories

Nozzle Jet Kit  
Pair of each Pencil & Fan Jets



6mm Microbore Hose Complete with Q21FH-6 & AHA.H6 Fittings



Stainless Metal Hose Reel  
50mtr of 12mm Extraflex Hose





# HIGHLINE™ 276

## CARGO SHIP CLEANING

The Highline™ 276 is a rugged mid-sized workhorse solution for demanding outdoor tasks such as gutter cleaning, cladding, wall surfaces, signs, decking, patios, paths, and driveways. Featuring a proven Honda GX390 petrol engine coupled via a gearbox to a renowned Comet geared triple plunger pump, this machine is the go-to choice for commercial work.

The compact yet robust trolley ensures easy transportation to and from the site, while the 13" flat-free wheels provide robustness and excellent manoeuvrability. Equipped with a 42" heavy-duty steel chrome dual lance, a 10mtr high-pressure twin wire rubber hose, and a variety of nozzles, including a chemical injector on the unloader, it guarantees smooth and reliable operation in any commercial setting.

### FEATURES

- GX390 Honda engine, recoil start
- Comet geared triple plunger pump with built-in unloader valve - for smooth & reliable operation
- 42" Heavy duty steel chrome dual lance with quick connector - for easy nozzle changes
- 10mtr High pressure twin wire rubber hose - for industrial use and longevity
- 3mtr 19mm Suction hose with weighted filter attached - for drawing from a sump
- Chemical injector on unloader with small filter attached - for drawing in detergents
- Assortment of 5 different nozzles, 15°, 25°, 40°, pencil and foaming tips - for every eventuality
- Heavy duty metal trolley with 13" flat-free wheels - for robustness and great manoeuvrability



### 1 System

## HIGHLINE™ 276



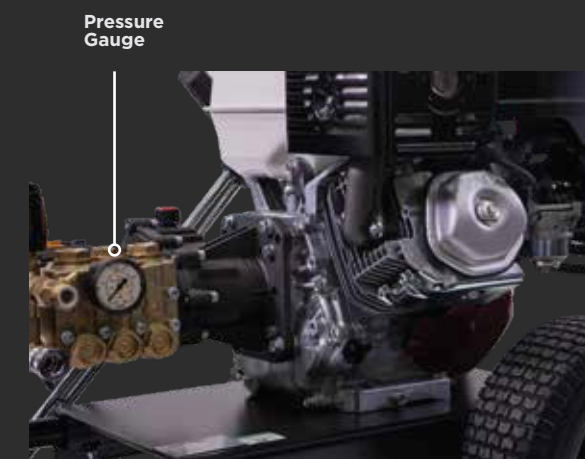
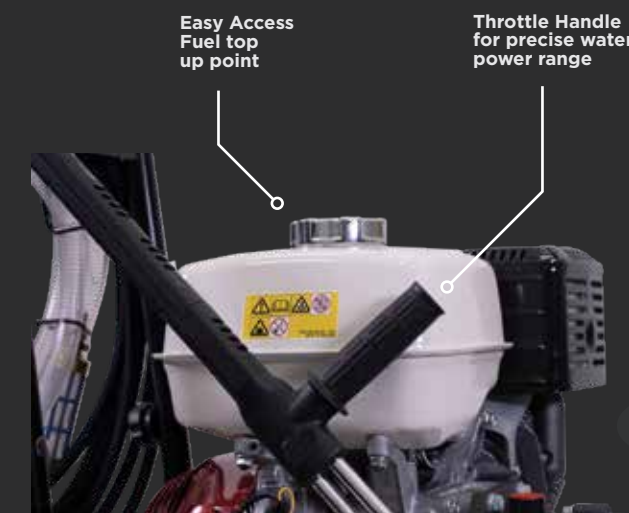

THIS KIT INCLUDES



**Cold Water** **Petrol**

Engine	Honda GX390
Max Rated Pressure	276Bar
Max Rated Flow	16Lpm
Max Rated Temp	60°C

---

Height	Width	Length	Weight
 100cm	 60cm	 110cm	 65.2kg

### 2 High Pressure Pole



Choose any Size from 17ft - 60ft See Page 78

Max. Water Pressure	Max. Temperature Rating	Clean Up To
276Bar	100°C	42ft

### OPTIONAL EXTRA



**12" Handheld Surface Cleaner**  
1/4 inch M Quick Release Coupler

Rated PSI	Max. Temperature Rating	Weight
3500Psi	82°C	3kg



# STREAMFLO® 25

## BUS & TRUCK CLEANING KIT

The Streamflo® 25 kit stands out as an essential cleaning kit for bus and truck cleaning professionals, offering a lightweight and robust mobile pure water trolley solution. This 25Ltr portable trolley system provides pure water on demand, ensuring spotless and streak-free surfaces for buses and trucks. Equipped with a powerful 100psi diaphragm pump, it elevates its cleaning capabilities.

The Streamline™ flow controller not only maximises flow but also contributes to water conservation. Its compact design, featuring collapsible handles for confined space storage, meets practical needs. The lightweight frame, with a handle on the front plate, ensures easy lifting and handling. The cleaning kit features a carbon fibre telescopic waterfed pole, a brush head, a 6mm microbore hose, and a nozzle jet kit including pencil and fan jets. Additionally, low-profile flat-free tyres make it suitable for rough terrains, providing versatility for bus and truck cleaning professionals in various scenarios.

### SYSTEM FEATURES

- Powerful 100psi diaphragm pump.
- Streamline™ flow controller to maximise flow and save wasting water.
- Compact design, with collapsible handles for storing in confined spaces.
- Lightweight frame with handle mounted on the front plate, for easy lifting and handling.
- Low profile flat-free tyres, for rough terrain.





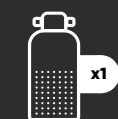

### 1 System



DI Vessel



Tank Size	25Ltr
Filtration	DI
Pump	100psi
Run Time	12hrs

Height	Width	Length	Weight
 115cm	 45cm	 65cm	 31kg

Water Area Range 0 - 150ppm

# STREAMFLO® 25



Control water flow speeds directly for tougher dirt



Charging Point (Removable Battery)

Flat Free all Terrain Wheels

### THIS KIT INCLUDES

#### 2 Waterfed Pole

Streamline™ OVA8® Carbon Fibre Waterfed Pole



Choose any Size from 14ft - 30ft | See Page 76

#### 3 Brush

Streamline™ Hi-Lo Angle Medium Bristle Brush



#### 4 Accessories

6mm Microbore Hose Complete with Q21FH-6 & AHA.H6 Fittings



Nozzle Jet Kit Pair of each Pencil & Fan Jets



Stainless Metal Hose Reel 50mtr of 12mm Extraflex Hose





# STREAMFLO® 120

## BUS & TRUCK CLEANING KIT

The Streamflo® 120 barrow kit is tailored to benefit bus and truck cleaning professionals, offering a compact and robust frame that ensures durability and reliability in the demanding field. Powered by a 100psi pump, it delivers a high flow rate of up to 1200 gallons per day, facilitating the quick and effective production of a large volume of pure water. The purpose-built 120Ltr profile water tank is mounted on a stable two-wheel trolley with large flat-free tyres, ensuring easy mobility.

The inclusion of the Streambox™ powerpack, featuring a 100psi pump, Lithium-Ion battery, and controller, enhances versatility, making it portable, easy to use, and adaptable to various bus and truck cleaning scenarios. The comprehensive system includes a waterfed, telescopic, carbon fibre pole with a brush head, a 6mm microbore hose reel, and a nozzle jet kit. With a 5mtr cable, operating pressure gauge, and hose connections for inlet, outlets, and waste water ports, this kit is perfectly suited for the practical needs of bus and truck cleaning professionals, ensuring ease of use and optimal performance.

### IDEAL FOR

- Multi Storey Buses
- Getting between Vents
- Moving around vehicle yards
- Windscreen and passenger windows



### 1 System

## STREAMFLO® 120

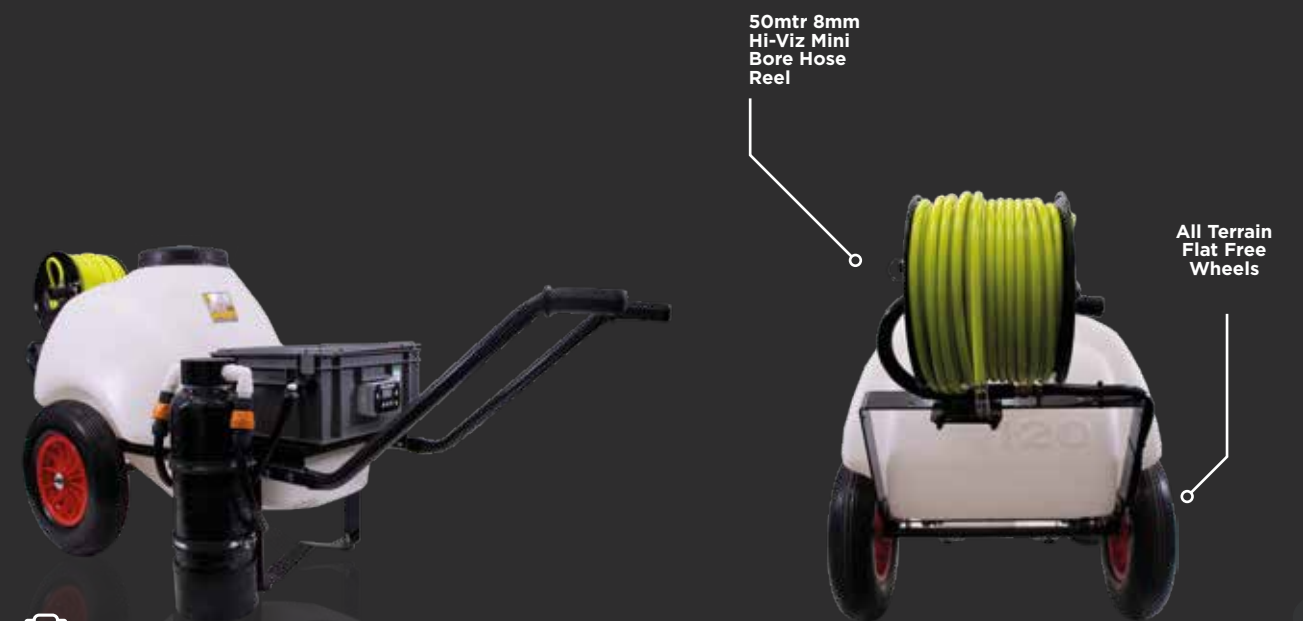

Tank Size	120Ltr
Filtration	DI
Pump	100psi
Run Time	12hrs
Height	115cm
Width	45cm
Length	65cm
Weight	31kg
Water Area Range	0 - 150ppm



### THIS KIT INCLUDES

#### 2 Waterfed Pole



Choose any Size from 14ft - 30ft | See Page 76

#### 3 Brush



Streamline™ Hi-Lo Angle Medium Bristle Brush

#### 4 Accessories

6mm Microbore Hose Complete with Q21FH-6 & AHA.H6 Fittings



Nozzle Jet Kit Pair of each Pencil & Fan Jets



Hose Connections Inlet, Outlets & Waste Water Ports





# HIGHLINE™ 150

## BUS & TRUCK CLEANING KIT

Tailored to benefit bus and truck cleaning professionals, this robust workhorse is specifically designed to efficiently tackle demanding outdoor tasks. With a reliable Honda GX160 petrol engine and an Interpump triple plunger pump, it excels in commercial applications critical to bus and truck maintenance.

The compact trolley, featuring 10" flat-free wheels, ensures effortless transportation to and from the site, enhancing mobility for the professional bus and truck cleaning operators. Its industrial-grade components, such as a 36" heavy-duty steel chrome single lance, a 10m high-pressure twin wire rubber hose, and a chemical injector on the unloader, make it a dependable and indispensable choice for day-to-day commercial use in the bus and truck cleaning industry. Offering a variety of nozzles and boasting robust construction, this machine guarantees smooth and reliable operation in any situation, ensuring optimal performance for bus and truck cleaning professionals.

### SYSTEM FEATURES

- GX160 Honda engine, recoil start
- Interpump triple plunger pump with built-in unloader valve - for smooth and reliable operation
- 36" Heavy duty steel chrome single lance with quick connector - for easy nozzle changes
- 10mtr High pressure twin wire rubber hose for industrial use and longevity
- 3mtr 19mm Suction hose with weighted filter attached - for drawing from a sump
- Chemical injector on unloader with small filter attached - for drawing in detergents
- Assortment of 5 different nozzles, 15°, 25°, 40°, pencil and foaming tips - for every eventuality.
- Heavy duty metal trolley with 10" flat-free wheels - for robustness and great manoeuvrability



### 1 System



Cold Water Petrol

Engine	Honda GX160		
Max Rated Pressure	DI		
Max Rated Flow	100psi		
Max Rated Temp	60°C		
-----			
Height	Width	Length	Weight
90cm	55cm	85cm	45.2kg

### HIGHLINE™ 150

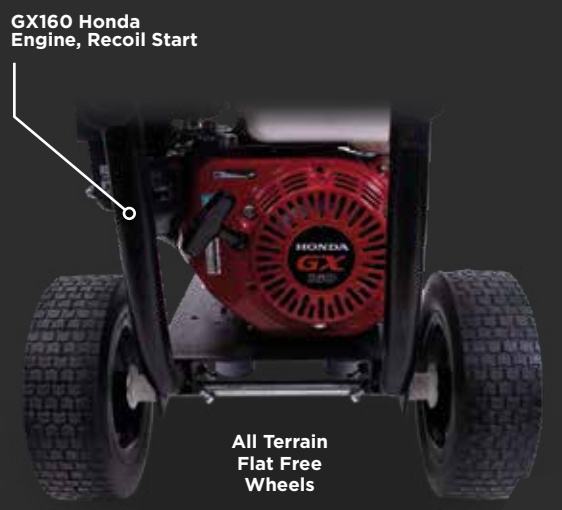

### THIS KIT INCLUDES

#### 2 High Pressure Pole



Choose any Size from 17ft - 60ft See Page 78

Max. Water Pressure	Max. Temperature Rating	Clean Up To
276Bar	100°C	25ft

### OPTIONAL EXTRA



12" Handheld Surface Cleaner  
1/4 inch M Quick Release Coupler

Rated PSI	Max. Temperature Rating	Weight
3500Psi	82°C	3kg



# HIGHLINE™ 276

## BUS & TRUCK CLEANING KIT

The Highline™ 276 Heavy Duty Cleaner, powered by the reliable Honda GX390 petrol engine, geared to an Italian-made Comet triple plunger pump, is specifically designed to cater to the demanding needs of bus and truck cleaning. Equipped with an industrial-grade dual lance, hose, and other robust hardware, this machine is your steadfast companion for consistent commercial performance day in and day out.

Its compact yet sturdy trolley facilitates easy transportation to and from the cleaning site. As the 'big daddy' of the range, this machine excels in delivering high pressure and flow, making it ideal for single and multiple nozzle applications, including rotary hard surface cleaners and water brooms. This all-rounder proves its versatility for various outdoor cleaning tasks. Featuring a GX390 Honda engine with recoil start, an Interpump triple plunger pump, and a 36" heavy-duty steel chrome single lance, along with other premium components, it ensures smooth and reliable operation for effective bus and truck cleaning.

### SYSTEM FEATURES

- GX390 Honda engine, recoil start
- Interpump triple plunger pump with built-in unloader valve - for smooth and reliable operation
- 42" Heavy duty steel chrome dual lance with quick connector - for easy nozzle changes
- 10mtr High pressure twin wire rubber hose for industrial use and longevity
- 3mtr 19mm Suction hose with weighted filter attached - for drawing from a sump
- Chemical injector on unloader with small filter attached - for drawing in detergents
- Assortment of 5 different nozzles, 15°, 25°, 40°, pencil and foaming tips - for every eventuality.
- Heavy duty metal trolley with 13" flat-free wheels - for robustness and great manoeuvrability



### 1 System



Additional Handle & Bumper Protection

Interpump triple plunger pump with built-in unloader valve

## HIGHLINE™ 276

THIS KIT ALSO INCLUDES

### 2 High Pressure Pole



Choose any Size from 17ft - 60ft See Page 78

Max. Water Pressure  
276Bar

Max. Temperature Rating  
100°C

Clean Up To  
42ft

### 4 Accessories

#### 22-inch (550mm) Flat Surface Cleaner

The cleaner glides easily across the surface, uniformly cleaning pool decks, sidewalks, garage floors, and more.



#### 12" Handheld Surface Cleaner

1/4 inch M Quick Release Coupler For cleaning Ceilings walls and floors



**Cold Water** **Petrol**

Engine	Honda GX390
Max Rated Pressure	276Bar
Max Rated Flow	16.8Lpm
Max Rated Temp	60°C

---

Height	Width	Length	Weight
100cm	110cm	60cm	65.2kg

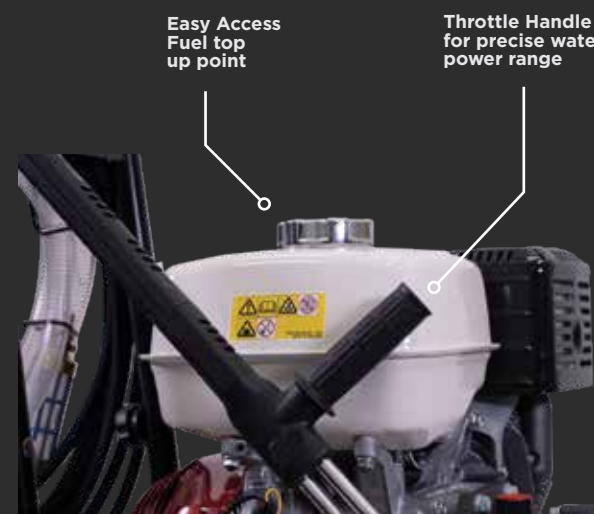



# STREAMFLO<sup>®</sup> 120

## TRAIN CLEANING KIT

The Streamflo<sup>®</sup> 120 train cleaning kit is an ideal solution with its compact and robust frame, ensuring unmatched durability and reliability. This comprehensive kit excels at removing up to 100% of dissolved impurities from water, facilitated by the powerful 100psi pump that generates a high flow rate of up to 1200 gallons per day. Perfect for demanding train cleaning applications, the purpose-built 120Ltr profile water tank is securely mounted on a stable two-wheel trolley with large flat-free tyres for convenient mobility.

The Streambox powerpack, featuring a 100psi pump, Lithium-Ion battery, and controller, enhances versatility, making it portable, user-friendly, and adaptable to various cleaning scenarios encountered by professional train cleaners. This kit is tailored to meet the specific needs of one operator. Moreover, the professional train cleaning kit includes essential components such as a telescopic waterfed pole with a brush head, nozzle jet kits, and a 6mm microbore hose, ensuring a comprehensive and efficient solution for train cleaning professionals.

### SYSTEM FEATURES

- Powerful 100psi diaphragm pump.
- Li-Ion battery will work 12hrs consistently on a full 6hr charge.
- Compact design, with detachable handles for storing in confined spaces.
- Low profile flat-free tyres, for rough terrain.
- Digital flow controller to adjust the speed of the pump



### 1 System



Easily Accessable Pump, Battery & Components



Operators	1
Tank Size	120Ltr
Filtration	DI
Pump	100psi
Run Time	12hrs

---

Height	Width	Length	Weight
115cm	45cm	65cm	31kg

# STREAMFLO<sup>™</sup> 120

THIS KIT ALSO INCLUDES

### 2 Waterfed Pole



Choose any Size from 4ft - 13ft | See Page 77

### 3 Brush



Streamline<sup>™</sup> Hi-Lo Angle Medium Bristle Brush

### 4 Accessories

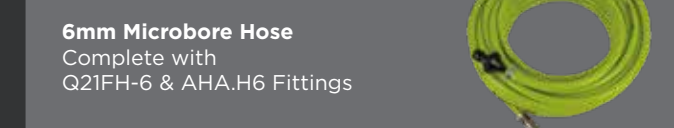

6mm Microbore Hose Complete with Q21FH-6 & AHA.H6 Fittings



Nozzle Jet Kit Pair of each Pencil & Fan Jets

Flat Free Tyres For All Terrains

Discrete Water Outlet Point



# STREAMFLO® 25

## BUS STOP CLEANING KIT

Tailored to enhance the experience for bus stop cleaners, the Streamflo® 25ltr portable trolley system brings a host of benefits to simplify and optimise cleaning tasks. The powerful 100psi diaphragm pump ensures a robust water flow, significantly improving the efficiency of the cleaning process. With the Streamline® flow controller, bus stop cleaners can maximise flow while saving water, contributing to both effectiveness and sustainability.

The compact design, featuring collapsible handles for easy storage in confined spaces, enhances convenience, allowing for seamless transportation and storage between cleaning sessions. The lightweight frame, with the handle strategically mounted on the front plate, ensures effortless lifting and handling for cleaners, reducing physical strain during operation. Additionally, the low-profile flat-free tyres are specifically designed for rough terrain, adding durability and stability to the trolley system.

### SYSTEM FEATURES

- Powerful 100psi diaphragm pump.
- Streamline® flow controller to maximise flow and save wasting water.
- Compact design, with collapsible handles for storing in confined spaces.
- Lightweight frame with handle mounted on the front plate, for easy lifting and handling.
- Low profile flat-free tyres, for rough terrain.



### 1 System



## STREAMFLO® 25



Tank Size	25Ltr		
Filtration	DI		
Pump	100psi		
Run Time	12hrs		
-----			
Height	Width	Length	Weight
115cm	45cm	65cm	31kg
Water Area Range		0 - 150ppm	



### THIS KIT ALSO INCLUDES

#### 2 Waterfed Pole



Choose any Size from 14ft - 25ft | See Page 76

#### 3 Brush

Streamline™ Hi-Lo Angle Medium Bristle Brush



#### 4 Accessories

6mm Microbore Hose Complete with Q21FH-6 & AHA.H6 Fittings



Nozzle Jet Kit Pair of each Pencil & Fan Jets





# STREAMFLO 120

## BUS STOP CLEANING KIT

The Streamflo® 120 barrow kit is specifically designed to cater to the needs of bus stop and bike shed cleaning professionals, providing a compact and robust frame that guarantees durability and reliability in their demanding tasks. Fuelled by a powerful 100psi pump, it ensures a high flow rate of up to 1200 gallons per day, facilitating the swift and efficient production of a substantial volume of pure water.

The purpose-built 120Ltr profile water tank is securely mounted on a stable two-wheel trolley with large flat-free tyres, ensuring seamless mobility for bus stop and bike shed cleaning. The inclusion of the Streambox powerpack, featuring a 100psi pump, Lithium-Ion battery, and controller, adds versatility to the system, making it portable, user-friendly, and adaptable to various cleaning scenarios. The comprehensive kit comprises essential components such as a waterfed, telescopic, carbon fibre pole with a brush head, a 6mm microbore hose reel, and a nozzle jet kit. This kit is meticulously tailored to meet the practical needs of bus stop and bike shed cleaning professionals, ensuring ease of use and optimal performance in their cleaning endeavours.

### SYSTEM FEATURES

- Powerful 100psi diaphragm pump.
- Li-Ion battery will work 12hrs consistently on a full 6hr charge.
- Compact design, with detachable handles for storing in confined spaces.
- Flat-free tyres, for rough terrain.
- Digital flow controller to adjust the speed of the pump



### 1 System

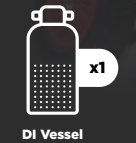

Operators	1
Tank Size	120Ltr
Filtration	DI
Pump	100psi
Run Time	12hrs

---

Height	Width	Length	Weight
115cm	45cm	65cm	31kg

# STREAMFLO 120

THIS KIT ALSO INCLUDES

### 2 Waterfed Pole



Choose any Size from 14ft - 25ft | See Page 76

### 3 Brush

Streamline™ Hi-Lo Angle Medium Bristle Brush



### 4 Accessories

6mm Microbore Hose Complete with Q21FH-6 & AHA.H6 Fittings



Nozzle Jet Kit Pair of each Pencil & Fan Jets



Control water flow speeds directly for tougher dirt



Easily Accessible Pump & Battery





**OVA8**



AVAILABLE IN 10 SIZES

Pole Code	Size	No. sections	Storeys	Weight
OV14-24-E	8.5ft / 2.6mtr	5	1	0.63kg
OV17-24-E	17ft / 5.1mtr	5	2	0.99kg
OV22-24-E	22ft / 6.7mtr	6	3	1.35kg
OV25-24-E	25ft / 7.7mtr	7	3	1.35kg
OV22-24-E-HIMOD	22ft / 6.7mtr	7	5	1.05kg
OV30-24-E	30ft / 7.7mtr	8	4	1.70kg
OV35-30-E	35ft / 10.7mtr	7	4	2.00kg
OV40-30-E	40ft / 12.4mtr	8	5	2.50kg
OV45-30-E	45ft / 12.7mtr	9	5	2.80kg
OV60-40-E	60ft / 18.2mtr	10	6	3.80kg



FEATURES

These professionally designed, water fed telescopic poles are ideal for window cleaning, cleaning solar panels, and cleaning conservatories. The lightweight, carbon fibre, ergonomically designed pole allows for a sturdy hand-held window cleaning pole – even at full height.

**100% Carbon Fibre**

**Zero Pole Spin**

**Flexi-5® Pole Tubing**



Super Lightweight



Quick Release OVA8® Attachments

**ECOLINE™**



AVAILABLE IN 3 SIZES

Pole Code	Size	No. sections	Storeys	Weight
GXTEL04E	4ft / 1.3mtr	2	1	0.42kg
GXTEL09E	9ft / 2.8mtr	2	1	0.69kg
GXTEL013E	13ft / 4mtr	3	2	1.07kg



FEATURES

The Ecoline™ range of glass fibre poles offer best value for money, whilst providing a professional pole for domestic and contract window cleaners alike.

**100% Glass Fibre**  
(Finished with acrylic resin)

**XTEL Clamps**

XTEL Clamps these feature strong locking force, polymer construction, dual left hand and right hand levers.

**Lite-5® Hi-viz Pole Tubing**

Hi-Viz ultra flexible pole tubing, providing suppleness and flex even in colder conditions.







HIGH PRESSURE POLE



AVAILABLE IN 4 SIZES

Pole Code	Achievable Height	No. sections	Storeys	Weight
HP-OV4-COMP	25ft / 7.62 mtr	4	2	4.28kg
HP-OV5-COMP	29ft / 8.8mtr	5	3	4.62kg
HP-OV6-COMP	33ft / 10mtr	6	4	5.02kg
HP-OV8-COMP	42ft / 12.8mtr	8	5	7.20kg

Max. Water Pressure

276Bar

Max. Temperature Rating

100°C

Clean Up To

42ft



FEATURES

Streamline™ OVA8® High Pressure Power Pole a unique high pressure configuration for the OVA8® Poles, enabling users to clean up 42ft with 4000psi 276bar. And because of the anti-spin pole section on the Streamline™ OVA8® pole, the oval shaped clamps work less due to only having to prevent the pole sections from moving up or down. The pole offers more rigidity and better control, as the two flat sides sits more comfortably in an operator's hand and allow the tips of their fingers to sit on the flat edge.

This product is really a cost-effective cleaning solution. It eliminates the need for additional cleaning equipment, such as ladders or scaffolding, which can be costly and time-consuming. Overall, the Streamline™ Power Pole is an excellent investment for anyone who needs a reliable and efficient cleaning tool for hard-to-reach areas.

100% Carbon Fibre

Zero Pole Spin

Super Lightweight

Quick Release Stainless Fitting





# External Floor Cleaning

- Patio Driveways**
- Carparks**
- Walkways**
- Bikeracks**
- Precincts**

At Streamline™, we specialise in manufacturing top-of-the-line solutions tailored to meet the diverse needs of outdoor maintenance. From pristine patio driveways to immaculate carparks, walkways, bike racks, and precincts, we've got you covered.

Our range of equipment is designed to deliver superior performance, efficiency, and durability, ensuring exceptional results with every use. Whether you're a homeowner, facility manager, or professional cleaner, our products are engineered to streamline your cleaning tasks and elevate the cleanliness of your outdoor spaces.



## Patio Driveways

Patio driveways often accumulate dirt, grime, and stubborn stains over time, detracting from their aesthetic appeal. Our high-pressure washers and surface cleaners are equipped with advanced technology to blast away even the toughest residues, restoring your patio driveway to its original pristine condition. With adjustable pressure settings and versatile nozzle options, our equipment ensures thorough cleaning without causing damage to delicate surfaces.

## Carparks

Carparks are notorious for accumulating oil spills, tire marks, and debris, posing both safety and aesthetic concerns. Our industrial-grade jet washers are engineered to tackle large areas quickly and effectively, sweeping away debris and scrubbing away stains with precision.

## Walkways & Bike Racks

Walkways and bike racks are high-traffic areas prone to dirt buildup, mould growth, and litter accumulation. Our compact and manoeuvrable pressure washers provide targeted cleaning solutions, reaching tight spaces and removing contaminants with precision.

## Precincts

Precincts encompass a variety of outdoor spaces, from public parks to shopping centres, requiring versatile cleaning solutions to maintain their cleanliness and appeal. Our pressure washers have powerful engines and durable components, built to withstand heavy-duty use in diverse environments, ensuring long-lasting performance and reliability.

Whether you're a homeowner, facility manager, or professional cleaner, our external floor cleaning equipment is designed to streamline your cleaning tasks and elevate the cleanliness of your outdoor spaces.

**01** FLOOR CLEANING

See Page 82 - 85

**02** BIKE RACKS

See Page 86 - 89

**03** ALL IN ONE VAN SYSTEM

See Page 90 - 91



# HIGHLINE™ 150

## EXTERNAL FLOOR CLEANING KIT

This is a versatile and rugged little work horse, capable of meeting the most demanding outdoor tasks on hand such as cleaning of gutters, cladding, wall surfaces, signs, decking, patios, paths and driveways, to name a few. The well-proven Honda GX160 petrol engine coupled to a well-known Interpump triple plunger pump, along with industrial grade single lance, hose and other hardware means that this machine is your reliable number one for commercial work, day in and day out. The compact yet robust trolley enables this machine to be easily transported to and from site.

### SYSTEM FEATURES

- GX160 Honda engine, recoil start
- Interpump triple plunger pump with built-in unloader valve - for smooth and reliable operation
- 36" Heavy duty steel chrome single lance with quick connector - for easy nozzle changes
- 10mtr High pressure twin wire rubber hose for industrial use and longevity
- 3mtr 19mm Suction hose with weighted filter attached - for drawing from a sump
- Chemical injector on unloader with small filter attached - for drawing in detergents
- Assortment of 5 different nozzles, 15°, 25°, 40°, pencil and foaming tips - for every eventuality.
- Heavy duty metal trolley with 10" flat-free wheels - for robustness and great manoeuvrability



### 1 System







### HIGHLINE™ 150



Cold Water Petrol

Engine	Honda GX160
Max Rated Pressure	DI
Max Rated Flow	100psi
Max Rated Temp	60°C

Height	Width	Length	Weight
 90cm	 55cm	 85cm	 45.2kg



### OPTIONAL EXTRAS

12" Handheld Surface Cleaner  
1/4 inch M Quick Release Coupler

HP-HSC300-QR



18-Inch (460mm) Flat Surface Cleaner

The cleaner glides easily across the surface, uniformly cleaning pool decks, sidewalks, garage floors, and more.

HP-HSC460

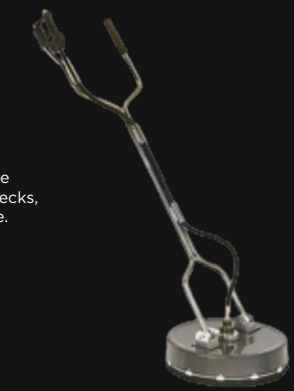

22-inch (550mm) Flat Surface Cleaner

The cleaner glides easily across the surface, uniformly cleaning pool decks, sidewalks, garage floors, and more.

Maximum Rated Pressure - 285 Bar (4,000 PSI)  
Maximum Rated Flow - 30.4 LPM (8.0 GPM)  
Maximum Rated Temperature - 85°C (180°F)

HP-HSC550-SS

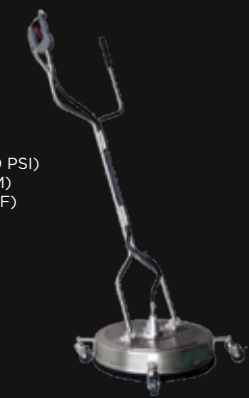



# HIGHLINE™ 276

## EXTERNAL FLOOR CLEANING KIT

The well-proven Honda GX390 petrol engine coupled via a gearbox to an Italian made Comet triple plunger pump, along with industrial-grade dual lance, hose and other hardware means that this machine is your reliable number one for commercial work, day in and day out. The compact yet robust trolley enables this machine to be easily transported to and from site.

This machine is the 'big daddy' of the range and is capable of delivering high pressure and flow for use in single and multiple nozzle applications, such as rotary hard surface cleaners and water brooms. An excellent all-rounder for all your outdoor cleaning tasks.

### SYSTEM FEATURES

- GX390 Honda engine, recoil start
- Interpump triple plunger pump with built-in unloader valve - for smooth and reliable operation
- 42" Heavy duty steel chrome dual lance with quick connector - for easy nozzle changes
- 10mtr High pressure twin wire rubber hose for industrial use and longevity
- 3mtr 19mm Suction hose with weighted filter attached - for drawing from a sump
- Chemical injector on unloader with small filter attached - for drawing in detergents
- Assortment of 5 different nozzles, 15deg, 25deg, 40deg, pencil and foaming tips - for every eventuality
- Heavy duty metal trolley with 13" flat-free wheels - for robustness and great manoeuvrability



### 1 System

## HIGHLINE™ 276





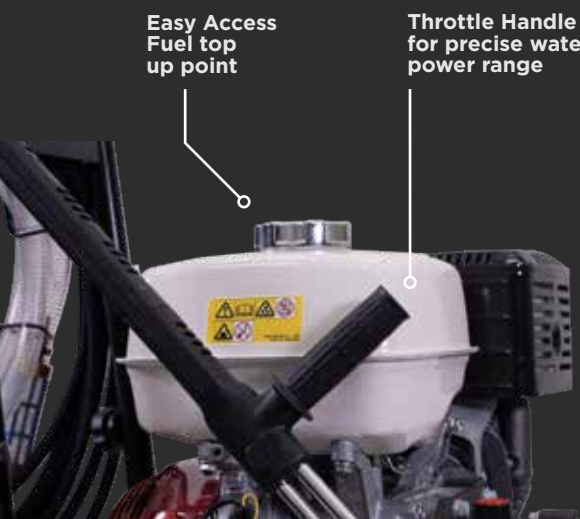

Integrated Spray Nozzle Holders



Easy Access Fuel top up point

Throttle Handle for precise water power range

	<b>Cold Water</b>	<b>Petrol</b>
Engine	Honda GX390	
Max Rated Pressure	276Bar	
Max Rated Flow	16.8Lpm	
Max Rated Temp	60°C	
Height	Width	Length
 100cm	 110cm	 60cm
		Weight
		 65.2kg

### OPTIONAL EXTRAS

12" Handheld Surface Cleaner  
1/4 inch M Quick Release Coupler

HP-HSC300-QR



18-Inch (460mm) Flat Surface Cleaner

The cleaner glides easily across the surface, uniformly cleaning pool decks, sidewalks, garage floors, and more.

HP-HSC460

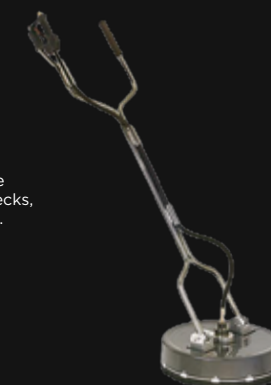

22-inch (550mm) Flat Surface Cleaner

The cleaner glides easily across the surface, uniformly cleaning pool decks, sidewalks, garage floors, and more.

Maximum Rated Pressure - 285 Bar (4,000 PSI)  
Maximum Rated Flow - 30.4 LPM (8.0 GPM)  
Maximum Rated Temperature - 85°C (180°F)

HP-HSC550-SS

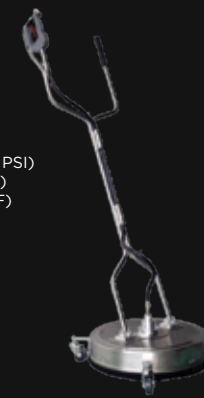



# STREAMFLO® 25

## BIKE RACK CLEANING KIT

The lightweight and robust window cleaners favourite mobile pure water trolley, The Streamflo™ 25ltr portable trolley system provides pure water on demand. Simply fill the container with tap water and it's ready to work, producing Oppm pure water on demand (version with resin filter only).

This is a commercial trolley built for the most demanding tasks, and is ideal for: professional window cleaners, contract cleaners, shopping centres, hotels, schools, hospitals, nursing homes, public houses, clubs etc.

### SYSTEM FEATURES

- Powerful 100psi diaphragm pump.
- Streamline™ flow controller to maximise flow and save wasting water.
- Compact design, with collapsible handles for storing in confined spaces.
- Lightweight frame with handle mounted on the front plate, for easy lifting and handling.
- Low profile flat-free tyres, for rough terrain.



### 1 System



**V16**  
Control water flow speeds directly for tougher dirt



Tank Size	25Ltr
Filtration	DI
Pump	100psi
Run Time	12hrs

Height	Width	Length	Weight
115cm	45cm	65cm	31kg

# STREAMFLO® 25

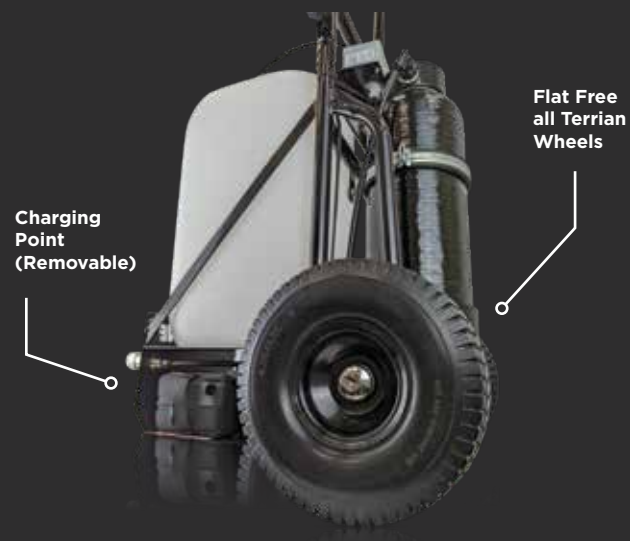

Charging Point (Removable)

Flat Free all Terrain Wheels

### INCLUDED WITH THIS KIT

#### 2 Waterfed Pole



Choose any Size from 4ft - 13ft | See Page 76

#### 3 Brush

Streamline™ Hi-Lo Angle Medium Bristle Brush



#### 4 Accessories

6mm Microbore Hose Complete with Q21FH-6 & AHA.H6 Fittings



Nozzle Jet Kit Pair of each Pencil & Fan Jets



Stainless Metal Hose Reel 50mtr of 12mm Extraflex Hose





# STREAMFLO 120

## BIKE RACK CLEANING KIT

The 120ltr Barrow System Kit is perfect for on-site cleaning of windows, gutters, fascia's and cladding in and around institutions such as school, colleges, shopping centres, business parks etc.

The purpose built 120ltr profile water tank is mounted on a two-wheel trolley with large flat-free tyres offering excellent stability, even when full. Fitted with our Streambox™ powerpack which includes a 100psi pump, Lithium-Ion battery and controller making it a versatile addition to the range.

### SYSTEM FEATURES

- Powerful 100psi diaphragm pump.
- Li-Ion battery will work 12hrs consistently on a full 6hr charge.
- Compact design, with detachable handles for storing in confined spaces.
- Flat-free tyres, for rough terrain.
- Digital flow controller to adjust the speed of the pump



### 1 System

## STREAMFLO™ 120

INCLUDED WITH THIS KIT

### 2 Waterfed Pole



Choose any Size from 4ft - 13ft | See Page 76

### 3 Brush

Streamline™ Hi-Lo Angle Medium Bristle Brush



### 4 Accessories

6mm Microbore Hose Complete with Q21FH-6 & AHA.H6 Fittings



Nozzle Jet Kit Pair of each Pencil & Fan Jets



Stainless Metal Hose Reel 50mtr of 12mm Extraflex Hose



Filter Stopping Dirt From Entering Tank, Protecting Pumps







DI Vessel



LI-ION

Tank Size	120Ltr
Filtration	DI
Pump	100psi
Run Time	12hrs

Height	Width	Length	Weight
 115cm	 45cm	 65cm	 31kg

Easily accessible Pump & Battery





# HOTCUBE™ VAN

## MULTI PURPOSE CLEANING

The Streamline™ Multi-Purpose vehicle package is designed to be used on larger commercial cleaning projects; it includes the dual operator Streamline® Bravo™ 650Ltr Reverse Osmosis Window Cleaning System complete with the Hotcube High Pressure Washer / Low Pressure Steam cleaning system drawing off one tank.

### Suitable For All

- ✓ Window Cleaning
- ✓ Chewing Gum Removal
- ✓ Jet Washing
- ✓ Roof & Render
- ✓ Graffiti Removal



### 1 Window Cleaning

- Dual Operator Bravo™ 650 Upright Reverse Osmosis + DI System.
- Split Charge Pro Relay System to charge battery whilst travelling
- 2 x Freestanding Hose Reels with 100m of 8mm Hi-Viz Streamline® Hose
- 22ft & 40ft Streamline™ OVA8® Carbon Fibre Poles
- Streamline® IPR5 Internal Pole Rack System

### 2 High Pressure Cleaning

- Hotcube™ 2 Diesel Powered Pressure Washer 18Lpm 350Bar – High Pressure + Low Pressure Steam Cleaning
- 2x Hose Reel with Guide 1x 100mtr of High Pressure Hose and 1x 100mtr of Low Pressure fill hose
- OVA8® Power Pole Carbon Fibre High Pressure Pole – 42ft Reach
- 22" Stainless Steel Rotary Hard Surface Cleaner with Castors
- Chewing Gum Removal Kit with Lance

### 3 Accessories

- Black Linex Polyurethane Waterproof Floor Coating
- Waterproof Internal Poly Lining Kit for van walls
- External Amber Warning Light Bar
- Chapter 8 Rear Door Chevron Graphics
- Wind Driven Roof Ventilation
- Twin Rack Vehicle Storage System
- LED Internal Work Lights with Swivel Base



Find Out More

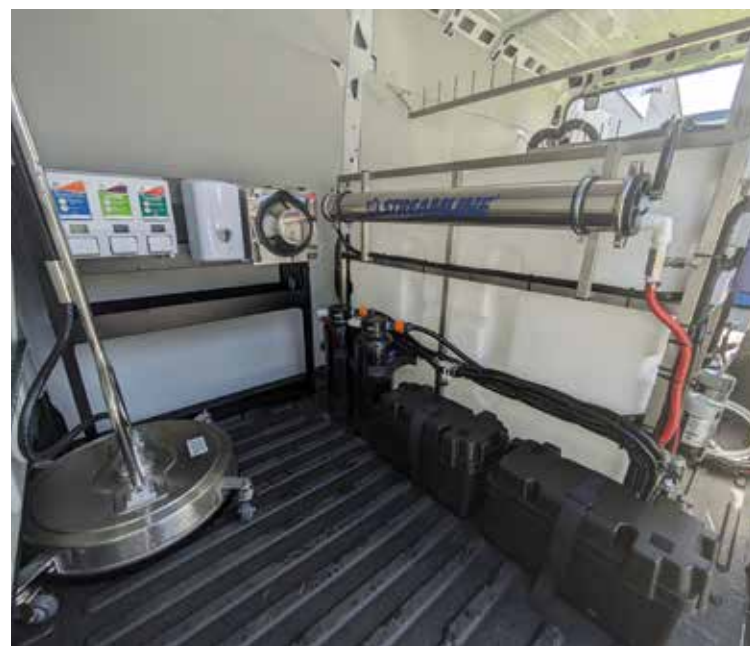



# Specialist Cleaning

## CCTV Cleaning High Reach Internal Dusting

Our range of specialist cleaning solutions addresses the unique needs of diverse industries and applications, offering several key benefits. These solutions are expertly formulated to tackle specific types of dirt and grime, providing enhanced cleaning performance compared to generic cleaners. Our CCTV cleaning kits ensure the optimal performance of surveillance systems, maintaining clear, high-quality imagery. Meanwhile, our high pressure cleaning tripod kits offer a secure platform for elevated pressure washing tasks, ideal for building exteriors and roofs. Additionally, our Streamvac™ internal vacuum kit provides a powerful and agile solution for cleaning high-level areas safely and efficiently, eliminating the need for cumbersome equipment like ladders.



01



### CCTV Cleaning

Introducing our specialist cleaning kit for CCTV systems. It comes with an extendable pole, making it the ultimate solution for maintaining crystal-clear surveillance footage and ensuring optimal performance of your security cameras.

See Page 94 - 95

02

### Internal Dusting

The Streamvac™ internal vacuum kit allows you to reach up to 10mtrs without the need of ladders or other lifting equipment, and enables you to vacuum up dust and dirt in high level applications. At the end of the pole is a vacuum head that can be fitted with a variety of attachments.



See Page 96 - 97



# DRAGONFLY® CCTV

## CCTV CLEANING KIT

Elevate your CCTV camera cleaning experience with the Dragonfly® kit. This portable powerhouse boasts an 8-hour rechargeable battery and a telescopic pole that delivers a fine mist of pure water to microfiber pads. Gently remove dirt, grime, and spider webs without damaging lenses, all while enjoying the lightweight backpack and carbon fiber pole for effortless maneuvering.

The Dragonfly® kit's poles can extend to just under 12mtrs, making it ideal for cleaning multiple cameras in large sites. Control the water flow remotely with the control fob and minimize downtime. With its easy portability and efficient cleaning capabilities, the Dragonfly® kit is your essential partner for maintaining clear and effective surveillance.

### SYSTEM FEATURES

- Microfiber Pads for Different Camera Types**  
 The kit includes two different microfiber pads, one for dome cameras and one for bullet cameras. This ensures that the pads are gentle on the delicate lenses of CCTV cameras and effectively remove dirt, grime, and spider webs without scratching or damaging the surface.
- Rechargeable Battery and Pump Kit**  
 The rechargeable battery and pump kit provide up to 8 hours of continuous operation, allowing you to clean multiple cameras without having to worry about re-charging the battery. The pump kit also ensures that a consistent flow of water is delivered to the microfiber pads, maximizing cleaning efficiency.
- Backpack Water Reservoir for Convenient Transportation**  
 The backpack water reservoir makes it easy to transport the cleaning kit to and from job sites. It also ensures that you have a readily available supply of water for cleaning cameras, regardless of where you are.





### 1 System



Tank Size	1.5Ltr
Flow Rate	3.8Lpm
Pump	40psi
Run Time	8hrs

Width	Length	Weight
		
45cm	65cm	921g

## DRAGONFLY® CCTV



Control water flow from up to 40ft at the press of a button.

1.5Ltr Easy Fill Reservoir

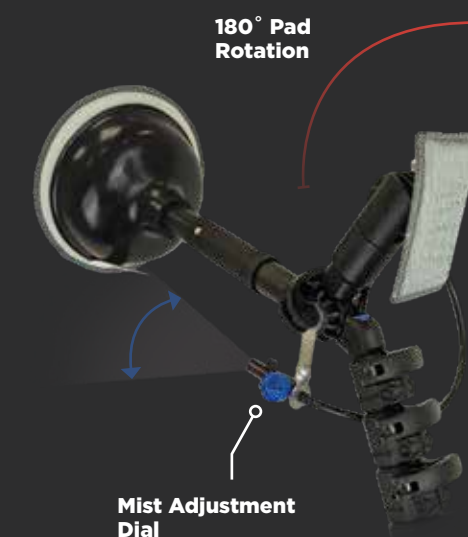

### INCLUDED WITH THIS KIT

#### 2 Waterfed Pole

### DRAGONFLY® OVA8®

Carbon Fibre Waterfed Pole



Choose any Size from 4ft - 13ft | See Page 14

#### 3 Microfibre Pads

10x Microfibre Scrub Mops  
Perfect for dome shaped CCTV Cameras allowing for a full clean



10x Microfibre Polishing Mops  
For smaller "bullet" CCTV lenses & tighter areas that require cleaning



#### 4 Accessories

- 1x Spray Assembly for OVA8®
- 1x 15mtr Pole Tubing
- 1x Spray Remote
- 2x Pole Tubing Straps
- 1x Battery Charger + International Plug Attachments



# STREAMVAC™

## INTERNAL DUSTING KIT

The Streamvac™ internal dry vacuum system allows you to reach up to 10mtr without the need of ladders or other lifting equipment, and enables you to vacuum up dust and dirt in high level applications.

The 230v Numatic vacuum system provides excellent suction for removing that dirt and dust.

The modular glass fibre pole sections are exceptionally light yet very rigid. These simply push into each other, creating a funnel effect, allowing reach up to 3.5mtr high. Various attachments can be fitted to the end of the pole section with a standard 32mm adapter supplied in the kit. The hose cuff of the vacuum attached to any of the pole sections. Each kit is supplied with a half section too, for versatility of use.

### SYSTEM FEATURES

- Powerful 620W motor
- Numatic high-efficiency, long-life motor.
- 10mtr cable for a large working radius.
- Strong and sturdy Ultralite™ carbon fibre poles. (Glass fibre also available)
- High-efficiency, triple-layer HepaFlo filter bags.
- Comes with many attachments so you can have the right tool for the job straight out of the box

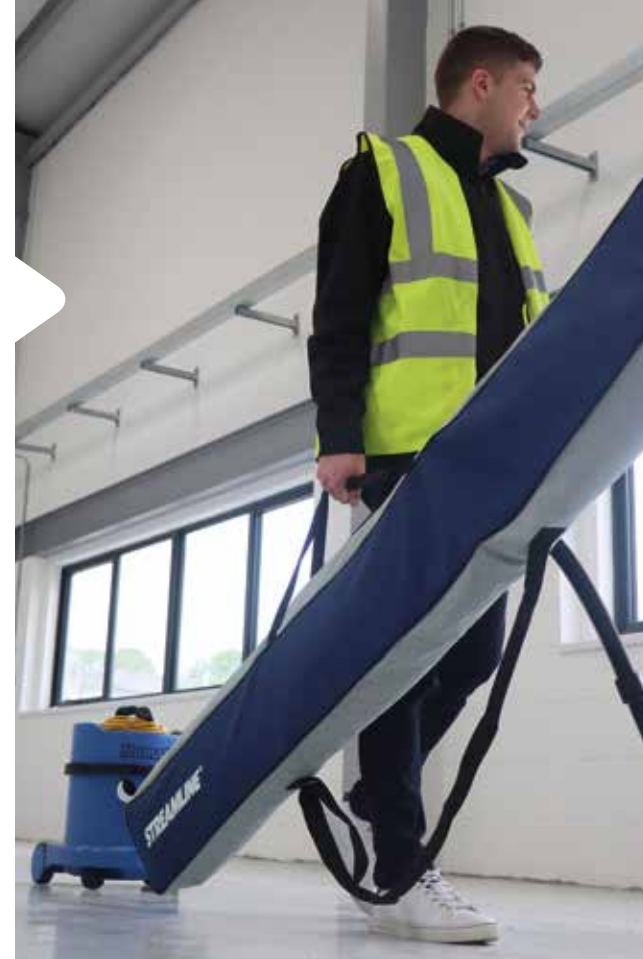

### 1 System



Drum Size	15Ltr
Air Flow	48Ltr Per Sec
Motor	680W
Voltage	230V

Height	Weight
 51cm	 9kg

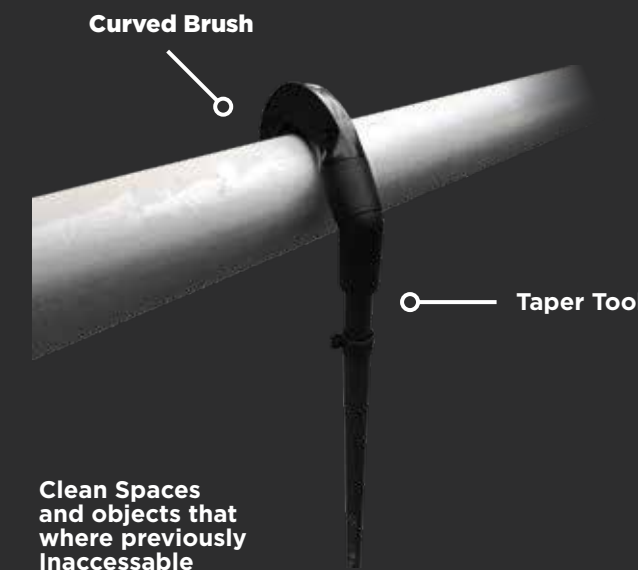

Clean Spaces and objects that were previously Inaccessible

### 2

Ultralite™ Top Sections  
Modular Carbon Fibre Pole

**18FT** 2x 6ft 38mm  
DV-KIT2175-038

---

**24FT** 3x 6ft 38mm  
DV-KIT4175-038

---

**38FT** 6x 6ft 38mm  
DV-KIT6175-038

### 3 Tools



**Sidewinder Dusting Brush**  
This dusting brush works great at getting into tight spaces and general hard floor cleanups.



**Soft Dusting Brush**  
These bristles gently dust delicate surfaces keeping shelves, blinds and lighting dust-free.



**Curved Brush**  
Perfect for vacuuming pipes and ducts.



**Taper Tool**  
Double taper tool adapter.

### 4 Accessories



**Holdall**  
Streamline designed with telescopic poles in mind.

### 5 OPTIONAL EXTRA



**CCTV Wireless Bullet Camera & Widescreen Monitor Kit**

See Page 53



## Our Team



### Our Purpose, Vision & Values

#### Purpose

Create Safety Through Innovation

#### Vision

To become a global leader in innovative specialist cleaning equipment.

#### Creative

Always challenging the status quo and nurturing innovative ideas to ensure we remain at the forefront of the high reach cleaning industry.

#### Passionate

Going the extra mile to show our customers they are the heart of our company. As a family owned company, we pride ourselves on our core values, ethics in treating both customers and employees with the utmost respect.

#### Safe

Our employees and our customers safety are our priority. We strive to produce the safest cleaning products whilst ensuring that our employees have a safe and healthy working environment.

#### Win Together

We build on our successes as a team, celebrate our wins and continue to learn. Valuing respect for each other is central to all we do. We respond to cultural trends and empower our team to engage with the wider community to create a united strategy that brings results.

## Contact

### Streamline™ UK

**Email:** sales@streamline.systems  
**Telephone:** 01626 830 830  
**Website:** www.streamline.systems

**Address:**  
 Hamilton House, 8 Fairfax Road,  
 Heathfield Industrial Estate,  
 Newton Abbot, Devon  
 TQ12 6UD

### Streamline™ France Corporate Office

**Email:** sales@streamline-eu.com  
**Telephone:** +33 (0) 4 89 51 86 30  
**Website:** www.streamline-eu.com

**Address:**  
 25 - 27, Rue Tronchet  
 75008 Paris  
 France

### Streamline™ Germany

**Email:** contact@streamline-eu.de  
**Telephone:** +49 2689 9463887  
**Website:** www.streamline-eu.de

**Address:**  
 Ringstrasse 19  
 56307 Dernbach (Neuwied)  
 Germany

## Terminology

### PPM (Parts Per Million)

A measured quantity of Total Dissolved Solids.

### TDS (Total Dissolved Solids)

Another measurement to indicate the purity of your water.

### TDS Meter (Total Dissolved Solids)

An electronic meter for accurately measuring Total Dissolved Solids. Provides a continuous digital readout to assess water quality.

### DI (Deionisation)

A chemical process that uses manufactured resins to filter dissolved minerals and impurities through a DI Vessel.

### RO (Reverse Osmosis)

A technology using semipermeable membranes to remove larger particulates from water, often used alongside deionised filtration.

### Hi-Mod (Hi-Modulus Carbon Fibre)

A strong but light material used in the construction of high-quality waterfed Poles.

## Special Thanks:

<b>Catalogue Lead Design:</b>	Brandon Dickons
<b>Photography:</b>	Thomas Eastwood, Brandon Dickons
<b>Photoshoot Planning:</b>	Thomas Eastwood, Vern Scott
<b>Marketing Manager:</b>	Keith Hathaway
<b>Models:</b>	Ziggy Phillips, Tommy Scott, Thomas Eastwood, Clive Ellis, Moors Cleaning Services, Jason Scott, Earl Hewison, Sam Hiles, Vern Scott.
<b>Technical Support:</b>	Clive Elis, Rod Scott
<b>Product Development Manager:</b>	Rob O'Neil
<b>Product Production Team:</b>	Stuart McCarthy, Sam Hiles, Dylan Haddrell
<b>Van Builds / Technicians:</b>	Jason Simmons, Chris Dabbs, Keith Schofield
<b>Quality Control:</b>	Marcus Williams
<b>Warehouse Team:</b>	Barnaby Vickery, Dave Hudson

This wouldn't have been possible without all your input.

We look forward to continuing to bring the best cleaning products to the world.



 **STREAMLINE™** | **Solutions**

**Hamilton House, 8 Fairfax Road,  
Heathfield Industrial Estate,  
Newton Abbot, Devon, England  
TQ12 6UD**

CATALOGUE REF CODE: SS2024-V1

[www.streamline.systems](http://www.streamline.systems)

Images and descriptions are a guide only  
and do not necessarily represent  
the products on offer. E & O.E.